

Operation and Service Guide

Agilent Technologies N5260A Millimeter Head Controller



Agilent Technologies

Part Number: N5260-90001

Printed in USA

Print Date: February 15, 2013

Supersedes: November 1, 2012

© Agilent Technologies, Inc. 2012–2013

WARRANTY STATEMENT

THE MATERIAL CONTAINED IN THIS DOCUMENT IS PROVIDED "AS IS," AND IS SUBJECT TO BEING CHANGED, WITHOUT NOTICE, IN FUTURE EDITIONS. FURTHER, TO THE MAXIMUM EXTENT PERMITTED BY APPLICABLE LAW, AGILENT DISCLAIMS ALL WARRANTIES, EITHER EXPRESS OR IMPLIED WITH REGARD TO THIS MANUAL AND ANY INFORMATION CONTAINED HEREIN, INCLUDING BUT NOT LIMITED TO THE IMPLIED WARRANTIES OF MERCHANTABILITY AND FITNESS FOR A PARTICULAR PURPOSE. AGILENT SHALL NOT BE LIABLE FOR ERRORS OR FOR INCIDENTAL OR CONSEQUENTIAL DAMAGES IN CONNECTION WITH THE FURNISHING, USE, OR PERFORMANCE OF THIS DOCUMENT OR ANY INFORMATION CONTAINED HEREIN. SHOULD AGILENT AND THE USER HAVE A SEPARATE WRITTEN AGREEMENT WITH WARRANTY TERMS COVERING THE MATERIAL IN THIS DOCUMENT THAT CONFLICT WITH THESE TERMS, THE WARRANTY TERMS IN THE SEPARATE AGREEMENT WILL CONTROL.

DFARS/Restricted Rights Notice

If software is for use in the performance of a U.S. Government prime contract or subcontract, Software is delivered and licensed as "Commercial computer software" as defined in DFAR 252.227-7014 (June 1995), or as a "commercial item" as defined in FAR 2.101(a) or as "Restricted computer software" as defined in FAR 52.227-19 (June 1987) or any equivalent agency regulation or contract clause. Use, duplication or disclosure of Software is subject to Agilent Technologies' standard commercial license terms, and non-DOD Departments and Agencies of the U.S. Government will receive no greater than Restricted Rights as defined in FAR 52.227-19(c)(1-2) (June 1987). U.S. Government users will receive no greater than Limited Rights as defined in FAR 52.227-14 (June 1987) or DFAR 252.227-7015 (b)(2) (November 1995), as applicable in any technical data.

Certification

Agilent Technologies, Inc. certifies that this product met its published specifications at the time of shipment from the factory. Agilent Technologies, Inc. further certifies that its calibration measurements are traceable to the United States National Institute of Standards and Technology, to the extent allowed by the Institute's calibration facility, and to the calibration facilities of other International Standards Organization members.

Assistance

Product maintenance agreements and other customer assistance agreements are available for Agilent Technologies, Inc. products. For information about these agreements and for other assistance, contact Agilent. Refer to "[Contacting Agilent](#)" on page 2-7.

Safety and Regulatory Information

The safety and regulatory information pertaining to this product is located in [Chapter 1, “Safety and Regulatory Information”](#).

Safety Notes

The following safety notes are used throughout this manual. Familiarize yourself with each of the notes and its meaning before operating this instrument. All pertinent safety notes for using this product are located in [Chapter 1, “Safety and Regulatory Information”](#).

WARNING **Warning denotes a hazard. It calls attention to a procedure which, if not correctly performed or adhered to, could result in injury or loss of life. Do not proceed beyond a warning note until the indicated conditions are fully understood and met.**

CAUTION Caution denotes a hazard. It calls attention to a procedure that, if not correctly performed or adhered to, could result in damage to or destruction of the instrument. Do not proceed beyond a caution sign until the indicated conditions are fully understood and met.

Printing Copies of Documentation from the Web

To print copies of documentation from the Web, download the PDF file from the Agilent web site:

- Go to <http://www.agilent.com>.
- Enter the document’s part number (located on the title page) in the Search box.
- Click **Search**.
- Click on the PDF to download it.
- Print the PDF.

Part I: System Installation and Operation

Chapter 1: Safety and Regulatory Information

Information in This Chapter	1-2
Chapter One at-a-Glance	1-2
Safety Symbols	1-3
General Safety Considerations	1-3
Safety Earth Ground	1-3
Before Applying Power	1-3
Servicing	1-4
Electrostatic Discharge Protection	1-5
Regulatory Information	1-6
Instrument Markings	1-6
Lithium Battery Disposal	1-7
Declaration of Conformity	1-7
EMC Information	1-7
Safety Information	1-7

Chapter 2: General Product Information, Maintenance, and Support

Information in This Chapter	2-2
Chapter Two at-a-Glance	2-2
What's Included in the Product?	2-3
General Product Description	2-3
Typical Configurations Using the N5260A	2-4
Maintenance	2-5
Physical Maintenance	2-5
Electrical Maintenance	2-5
Caring for Waveguide (WG) Interfaces	2-5
Principles of Connector Care	2-6
Agilent Support, Services, and Assistance	2-7
Service and Support Options	2-7
Contacting Agilent	2-7
Shipping an Item to Agilent for Service or Repair	2-7

Chapter 3: Installation and Operation

Information in This Chapter	3-2
Chapter Three at-a-Glance	3-2
Conventions Used for Hardkeys, Softkeys, and Menu Items	3-2
Front Panel Features	3-3
Rear Panel Features	3-5
Receiving the N5260A	3-7
The N5260A as Shipped	3-7
System Contents	3-8
Site Preparation	3-9
Power Requirements	3-9
Environmental Requirements	3-10
Protect Against Electrostatic Discharge (ESD)	3-11

Contents

Review the Principles of Connector Care	3-11
Space Requirements	3-11
PNA, Controller, and Millimeter-Wave Module Interconnections	3-13
Rear Panel Cabling	3-13
Front Panel Cabling	3-14
Sequence of Test Head Module Connections	3-15
System Cable Connections	3-16
Configuring the PNA Software for Banded Millimeter Head Operation	3-17

Chapter 4: Operator's Check

Information in This Chapter	4-2
Chapter Four at-a-Glance	4-2
Conventions Used for Hardkeys, Softkeys, and Menu Items	4-2
System Operation Check	4-3
Long Term Storage of Test Results	4-3
Required Equipment	4-3
Information Required for the Operator's Check	4-3
Preparing the System	4-4
Calibration Kit	4-4
Operator's Check Procedure	4-4

Chapter 5: System Troubleshooting and Repair

Information in This Chapter	5-2
Chapter Four at-a-Glance	5-2
Conventions Used for Hardkeys, Softkeys, and Menu Items	5-2
Troubleshooting	5-3
Equipment Required but not Supplied	5-3
Troubleshooting Flowchart	5-3
Troubleshooting Procedures	5-5
System Repair and Calibration	5-11

Part II: Test Set Service

Chapter 6: Specifications and Theory of Operation

Information in This Chapter	6-2
Chapter Five at-a-Glance	6-2
Specifications	6-3
Supplemental Characteristics	6-3
Power Requirements and Physical Characteristics	6-4
Theory of Operation	6-5
RF Section	6-5
LO Section	6-5
Input and Output Connectors	6-5
Test Set Interface	6-5

Contents

Chapter 7: Test Set Repair

Information in This Chapter	7-2
Chapter Six at-a-Glance	7-2
Personal Safety Warnings	7-3
Protect Against Electrostatic Discharge (ESD)	7-3
Repair	7-4
Removing and Replacing External Parts	7-5
Removing and Replacing Front Panel Parts	7-6
Removing and Replacing the A1 and A21 Power Supply Boards	7-10
Removing and Replacing the A3 and A8 Buffer Amplifiers	7-12
Removing and Replacing the A4 and A7 Modulator/Amplifiers and the A5 and A6 Bias Boards	7-14
Removing and Replacing the A9 Test Set Interface Control Board	7-16
Removing and Replacing the A10 and A16 Couplers	7-18
Removing and Replacing the A11, A12 and A17 Attenuators and the A13 and A18 Detectors	7-20
Removing and Replacing the A14 RF Switch	7-22
Removing and Replacing the A19 Power Divider	7-24
Removing and Replacing the A15 and A20 Isolators	7-26
Removing and Replacing the Fan	7-28
Removing and Replacing the A2 AC Line Module and Line Fuse	7-30
Removing and Replacing the Power Supply Fuses	7-32

Chapter 8: Replaceable Parts

Information in This Chapter	8-2
Chapter Seven at-a-Glance	8-2
Ordering Information	8-2
Replaceable Parts	8-3
Front Panel	8-4
Internal Assemblies	8-6
RF Cables	8-8
Wire Harness and Ribbon Cables	8-10
Internal Hardware and Miscellaneous Parts	8-12
Rear Panel	8-14
Chassis	8-16
Miscellaneous	8-18

Chapter 9: Test Set Adjustments and Tests

Information in This Chapter	9-2
Chapter Nine at-a-Glance	9-2
Conventions Used for Hardkeys, Softkeys, and Menu Items	9-2
Introductory Information	9-2
When Adjustments and Tests are Required	9-2
Required Test Equipment	9-2
Controlling the N5260A Test Set with a PNA	9-3
Setting the Sweep and Power Level Output on the PNA	9-3
Adjustment Procedures	9-4
Bias Supply Voltage Adjustment	9-4
RF and LO Adjustments	9-5
Test Procedure	9-7

Contents

Troubleshooting	9-8
Frequency Step Macro	9-8

Part I: System Installation and Operation

Part I of this manual covers a system based on an N5260A test set. A typical system consists of a PNA, an N5260A test set, and two OML banded millimeter heads.

Chapter 1, "Safety and Regulatory Information"	
Safety Symbols	Descriptions of CAUTION and WARNING symbols used throughout this manual.
General Safety Considerations	A list of safety points to consider when servicing your N5260A.
Electrostatic Discharge Protection	A discussion of electrostatic discharge (ESD) and related recommendations and requirements for ESD protection.
Regulatory Information	Definitions of instrument markings, Declaration of Conformity DoC), EMC directive compliance, and safety directive compliance.
Chapter 2, "General Product Information, Maintenance, and Support"	
What's Included in the Product?	A list of the items that are included with your N5260A shipment.
General Product Description	A general description of the N5260A and how it is used in a typical measurement system.
Maintenance	Cleaning instructions for the external surfaces and information about electrical maintenance of your N5260A.
Caring for Waveguide (WG) Interfaces	Instructions on how to care for waveguide interfaces.
Principles of Connector Care	Instructions on how to care for waveguide interfaces.
Agilent Support, Services, and Assistance	The Internet address (URL) for on-line assistance, service and support options available, and important information about shipping your N5260A to Agilent for service or repair.
Chapter 3, "Installation and Operation"	
Front Panel Features	Descriptions of all front panel connectors, LEDs, and other items including the intended use for each.
Rear Panel Features	Descriptions of all rear panel connectors including the intended use for each.
Receiving the N5260A	Descriptions of the system components and Agilent custom engineering.
Site Preparation	Descriptions of power requirements, environmental requirements, protections from ESD, and space requirements.
PNA, Controller, and Millimeter-Wave Module Interconnections	Descriptions of rear panel cabling, front panel cabling, and the sequence of test head module connections.
System Cable Connections	Descriptions of from/to connections for the E8361A network analyzer, the N5260A millimeter head controller, and the left and right test head modules
Chapter 4, "Operator's Check"	
System Operation Check	Description of the operator's check.
Chapter 5, "System Troubleshooting and Repair"	
Troubleshooting	Description of the operator's check.

Chapter 1: Safety and Regulatory Information

Information in This Chapter

This chapter provides safety information that will help protect you and your N5260A millimeter head controller. It also contains information that is required by various government regulatory agencies.

Chapter One at-a-Glance

Section Title	Summary of Content	Start Page
Safety Symbols	Descriptions of CAUTION and WARNING symbols used throughout this manual.	Page 1-3
General Safety Considerations	A list of safety points to consider when servicing your N5260A millimeter head controller.	Page 1-3
Electrostatic Discharge Protection	A discussion of electrostatic discharge (ESD) and related recommendations and requirements for ESD protection.	Page 1-5
Regulatory Information	Definitions of instrument markings. Declaration of Conformity (DoC). EMC directive compliance. Safety directive compliance.	Page 1-6

Safety Symbols

The following safety symbols are used throughout this manual. Familiarize yourself with each of the symbols and its meaning before operating this instrument.

CAUTION Caution denotes a hazard. It calls attention to a procedure that, if not correctly performed or adhered to, could result in damage to or destruction of the instrument. Do not proceed beyond a caution note until the indicated conditions are fully understood and met.

WARNING Warning denotes a hazard. It calls attention to a procedure which, if not correctly performed or adhered to, could result in injury or loss of life. Do not proceed beyond a warning note until the indicated conditions are fully understood and met.

General Safety Considerations

Safety Earth Ground

WARNING This is a Safety Class I product (provided with a protective earthing ground incorporated in the power cord). The mains plug shall only be inserted in a socket outlet provided with a protective earth contact. Any interruption of the protective conductor, inside or outside of the instrument, will make the instrument dangerous. Intentional interruption is prohibited.

CAUTION Always use the three-prong AC power cord supplied with this product. Failure to ensure adequate grounding by not using this cord may cause product damage.

Before Applying Power

CAUTION Make sure that the analyzer line voltage selector switch is set to the voltage of the power supply and the correct fuse is installed.

CAUTION If this product is to be energized via an autotransformer make sure the common terminal is connected to the neutral (grounded side of the mains supply).

CAUTION This product is designed for use in Installation Category II and Pollution Degree 2 per IEC 1010 and 664 respectively.

Servicing

WARNING These servicing instructions are for use by qualified personnel only. To avoid electrical shock, do not perform any servicing unless you are qualified to do so.

WARNING The opening of covers or removal of parts may expose dangerous voltages. Disconnect the instrument from all voltage sources while it is opened.

WARNING Danger of explosion if battery is incorrectly replaced. Replace only with the same or equivalent type recommended. Discard used batteries according to manufacturer's instructions.

WARNING Procedures described in this document may be performed with power supplied to the product while protective covers are removed. Energy available at many points may, if contacted, result in personal injury.

WARNING The power cord is connected to internal capacitors that may remain live for 10 seconds after disconnecting the plug from its power supply.

WARNING For continued protection against fire hazard, replace line fuse only with same type and rating. The use of other fuses or material is prohibited.

WARNING The detachable power cord is the instrument disconnecting device. It disconnects the mains circuits from the mains supply before other parts of the instrument. The front panel switch is only a standby switch and is not a LINE switch (disconnecting device).

Electrostatic Discharge Protection

Protection against electrostatic discharge (ESD) is essential while removing assemblies from or connecting cables to the instrument. Static electricity can build up on your body and can easily damage sensitive internal circuit elements when discharged. Static discharges too small to be felt can cause permanent damage. To prevent damage to the instrument:

- *always* wear a grounded wrist strap having a 1 M Ω resistor in series with it when handling components and devices or when making connections to the test set.
- *always* use a grounded, conductive table mat while making connections.
- *always* wear a heel strap when working in an area with a conductive floor. If you are uncertain about the conductivity of your floor, wear a heel strap.
- *always* ground yourself before you clean, inspect, or make a connection to a static-sensitive device or test port. You can, for example, grasp the grounded outer shell of the test port or cable connector briefly.
- *always* ground the center conductor of a test cable before making a connection to the analyzer test port or other static-sensitive device. This can be done as follows:
 1. Connect a short (from your calibration kit) to one end of the cable to short the center conductor to the outer conductor.
 2. While wearing a grounded wrist strap, grasp the outer shell of the cable connector.
 3. Connect the other end of the cable to the test port.
 4. Remove the short from the cable.

Figure 1-1 shows a typical ESD protection setup using a grounded mat and wrist strap.

Figure 1-1 ESD Protection Setup

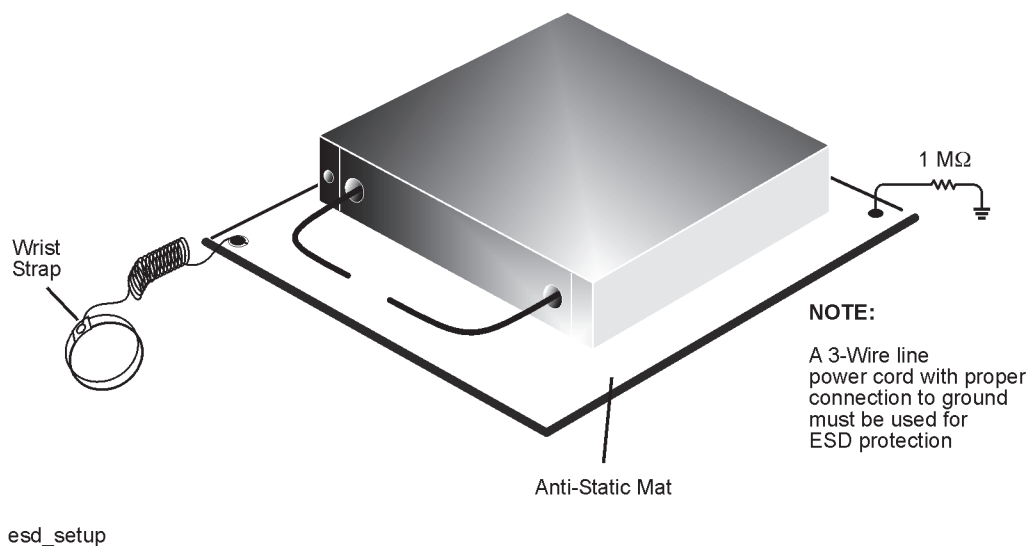

Regulatory Information

This section contains information that is required by various government regulatory agencies.

Instrument Markings

Familiarize yourself with these instrument markings and their meanings before operating the instrument.



The instruction documentation symbol. The product is marked with this symbol when it is necessary for the user to refer to the instructions in the documentation.



This symbol indicates that the instrument requires alternating current (ac) input.



This symbol indicates separate collection for electrical and electronic equipment, mandated under EU law as of August 13, 2005. All electric and electronic equipment are required to be separated from normal waste for disposal (Reference WEEE Directive, 2002/96/EC).



This symbol indicates that the power line switch is ON.



This symbol indicates that the power line switch is in the STANDBY position.



This symbol indicates that the power line switch is in the OFF position.



This symbol is used to identify a terminal which is internally connected to the product frame or chassis.



The CE mark is a registered trademark of the European Community. (If accompanied by a year, it is when the design was proven.)



The CSA mark is a registered trademark of the CSA International. This instrument complies with Canada: CSA 22.2 No. 61010-1-04.



This is a symbol of an Industrial Scientific and Medical Group 1 Class A product.



This is a marking to indicate product compliance with the Canadian Interference-Causing Equipment Standard (ICES-001).



Direct Current.



This is a required mark signifying compliance with an EMC requirement. The C-Tick mark is a registered trademark of the Australian Spectrum Management Agency.



Indicates the time period during which no hazardous or toxic substance elements are expected to leak or deteriorate during normal use. Forty years is the expected useful life of the product.



This symbol on all primary or secondary packaging indicates compliance to China standard GB 18455-2001.



This Korean Certification (KC) symbol is required for products that are subject to legally compulsory certification. The KC symbol includes the marking's identifier code that has up to 26 digits and follows this format: KCC-VWX-YYY-ZZZZZZZZZZZZZ.

Lithium Battery Disposal

If the battery on the network analyzer's CPU board needs to be disposed of, dispose of it in accordance with your country's requirements. If required, you may return the battery to Agilent Technologies for disposal. For assistance refer to "Contacting Agilent" on page 2-7.



DO NOT THROW BATTERIES AWAY BUT
COLLECT AS SMALL CHEMICAL WASTE.

Declaration of Conformity

A copy of the Declaration of Conformity is available upon request, or a copy is available on the Agilent Technologies web site at: <http://regulations.corporate.agilent.com/DoC/search.htm>.

EMC Information

Complies with European EMC Directive 2004/108/EC

- IEC/EN 61326-2-1
- CISPR Pub 11 Group 1, class A
- AS/NZS CISPR 11
- ICES/NMB-001

Safety Information

Complies with European Low Voltage Directive 2006/95/EC

- IEC/EN 61010-1, 2nd edition
- Canada: CSA C22.2 No. 61010-01-04
- USA: UL std. no. 61010-1, 2nd edition

Chapter 2: General Product Information, Maintenance, and Support

Information in This Chapter

Chapter Two at-a-Glance

Section Title	Summary of Content	Start Page
What's Included in the Product?	A list of the items that are included with your N5260A millimeter head controller shipment.	Page 2-3
General Product Description	A general description of the N5260A millimeter head controller and how it is used in a typical measurement system.	Page 2-3
Maintenance	Cleaning instructions for the external surfaces of your N5260A millimeter head controller. Information about electrical maintenance of your N5260A millimeter head controller.	Page 2-5
Caring for Waveguide (WG) Interfaces	Instructions on how to care for waveguide interfaces.	Page 2-5
Principles of Connector Care	Instructions on how to care for waveguide interfaces.	Page 2-6
Agilent Support, Services, and Assistance	The Internet address (URL) for on-line assistance. Service and support options available. Important information about shipping your N5260A millimeter head controller to Agilent for service or repair.	Page 2-7

What's Included in the Product?

Each N5260A millimeter head controller product includes:

- The N5260A millimeter head controller
- Interconnection cables and adapters to interconnect the system components. For the complete list, refer to the N5260A section of [Table 3-1 on page 3-8](#).
- The N5260A Millimeter Head Controller Operation and Service Guide (the document you are now reading). This document provides detailed system information for using an N5260A millimeter head controller with banded millimeter-wave test head modules from OML.

The information in this manual assumes that an N5260A controller is used with a pair of transmit/reflection (T/R) modules. Configurations using other types of modules are not covered in this manual.

The N5260A may also be used as part of the N5250A/C Microwave Network Analyzer System. Refer to the N5250A/C document (Agilent part number N5250-90001) for detailed system information. If a printed version of the N5250A/C manual is not available, refer to [“Printing Copies of Documentation from the Web” on page iii](#) of this manual.

General Product Description

The N5260A millimeter head controller provides the interface between the millimeter-wave test head modules and a PNA series network analyzer with Option H11.

The millimeter head controller, when used in conjunction with the millimeter-wave test head modules and the PNA, provides all of the features and functions of a full S-Parameter test set.

The millimeter head controller supplies RF and LO signals to the millimeter-wave test head modules and returns the down converted reference and test IF signals to the PNA for process and display. The N5260A millimeter head controller also supplies the +12 volt bias to each millimeter-wave head module.

The front panel of the N5260A millimeter head controller is illustrated in [Figure 2-1](#).

A typical system configuration is illustrated in [Figure 2-2](#).

For information on the N5260A as part of the N5250A/C network analyzer system and information on the millimeter-wave test head modules, see the N5250A/C Installation and Service Guide. For application information, see the PNA Microwave Network Analyzers Application Note 1408-15, “Banded Millimeter-Wave Measurements with the PNA” (Agilent part number 5989-4098EN). Although portions of this Application Note may need updating to include new equipment, it still contains relevant information.

If a printed version of these documents is not available, refer to [“Printing Copies of Documentation from the Web” on page iii](#) of this manual.

Figure 2-1. N5260A Millimeter Head Controller Front Panel

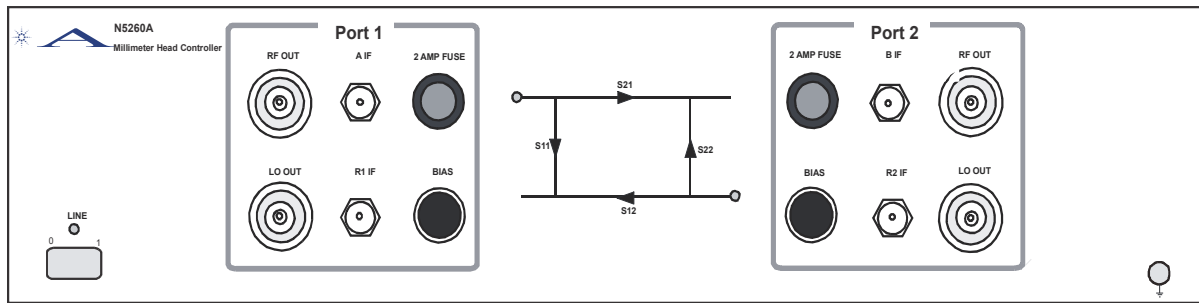

n5250_001_309

Typical Configurations Using the N5260A

Figure 2-2 Typical Banded Millimeter Wave Configuration

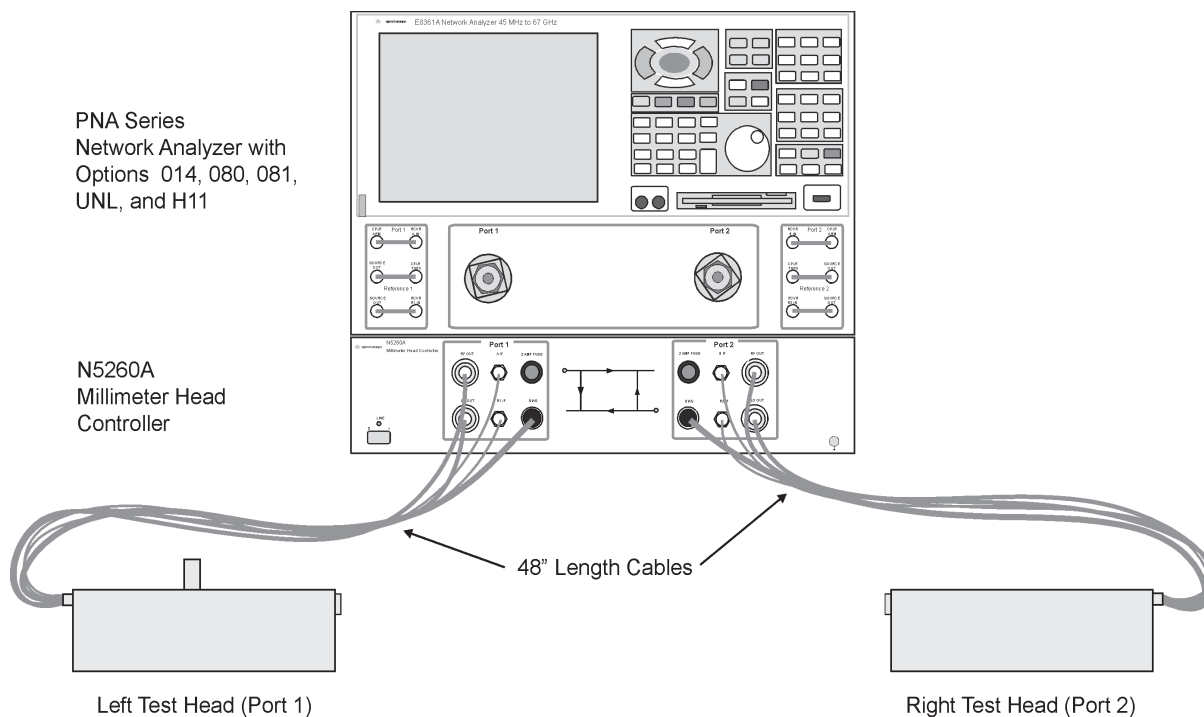

n5250_001_312

Maintenance

WARNING To prevent electrical shock, disconnect the instrument from the mains source before cleaning. Use a dry cloth or one slightly dampened with water to clean the external case parts. Do not attempt to clean internally.

Physical Maintenance

Clean the cabinet, including the front panel, using a dry or slightly damp cloth only.

Electrical Maintenance

Refer to “Agilent Support, Services, and Assistance” on page 2-7.

Caring for Waveguide (WG) Interfaces

A clean surface at millimeter-wave frequencies is much more important than at lower frequencies because any debris on the waveguide surface can potentially distort the measurement results.

Caring for WG interfaces is not difficult. Dirt and dust can be removed using the following:

- Isopropyl alcohol 99.5%¹
- Lint-free cloth
- Pressurized air (for dust removal)

To remove dirt on the waveguide surface, simply put a few drops of isopropyl alcohol on a lint-free cloth and gently wipe the surface.

To remove dust, simply spray the pressurized air on the waveguide surface.

1. Use isopropyl alcohol only in a well-ventilated area. Allow all residual alcohol moisture to evaporate, and the fumes to dissipate, prior to assembling waveguide interfaces.

Principles of Connector Care

Proper connector care and connection techniques are critical for accurate and repeatable measurements. Refer to [Table 2-1](#) for tips on connector care.

Prior to making connections to your analyzer, carefully review the information about inspecting, cleaning, and gaging connectors. Refer to the calibration kit documentation for detailed connector care information.

For course numbers about additional connector care instruction, contact Agilent Technologies. Refer to [“Contacting Agilent”](#) on page 2-7.

Table 2-1 Connector Care Quick Reference Guide

Handling and Storage	
Do <ul style="list-style-type: none"> Keep connectors clean Extend sleeve or connector nut Use plastic end-caps during storage 	Do Not <ul style="list-style-type: none"> Touch mating-plane surfaces Set connectors contact-end down Store connectors or adapters loose
Visual Inspection	
Do <ul style="list-style-type: none"> Inspect all connectors carefully Look for metal particles, scratches, and dents 	Do Not <ul style="list-style-type: none"> Use a damaged connector - ever
Connector Cleaning	
Do <ul style="list-style-type: none"> Try compressed air first Use isopropyl alcohol^a Clean connector threads 	Do Not <ul style="list-style-type: none"> Use any abrasives Get liquid into plastic support beads
Gaging Connectors	
Do <ul style="list-style-type: none"> Clean and zero the gage before use Use the correct gage type Use correct end of calibration block Gage all connectors before first use 	Do Not <ul style="list-style-type: none"> Use an out-of-specification connector
Making Connections	
Do <ul style="list-style-type: none"> Align connectors carefully Make preliminary connection contact lightly Turn only the connector nut Use a torque wrench for final connection 	Do Not <ul style="list-style-type: none"> Apply bending force to connection Over tighten preliminary connection Twist or screw any connection Tighten past torque wrench “break” point

- a. Cleaning connectors with alcohol shall only be done with the instrument’s power cord removed, and in a well-ventilated area. Allow all residual alcohol moisture to evaporate, and the fumes to dissipate, prior to energizing the instrument.

Agilent Support, Services, and Assistance

Information on the following topics is included in this section.

- “Service and Support Options”
- “Contacting Agilent”
- “Shipping an Item to Agilent for Service or Repair”

Service and Support Options

The N560A millimeter head controller has a *one-year return to Agilent Technologies* service warranty.

NOTE There are many repair and calibration options available from the Agilent Technologies support organization. These options cover a range of service agreements with varying response times. Contact Agilent for additional information on available service agreements for this product. Refer to “Contacting Agilent” on page 2-7.

Contacting Agilent

Assistance with test and measurements needs and information or finding a local Agilent office are available on the Web at:

<http://www.agilent.com/find/assist>

If you do not have access to the Internet, please contact your Agilent field engineer.

NOTE In any correspondence or telephone conversation, refer to the Agilent product by its model number and full serial number. With this information, the Agilent representative can determine whether your product is still within its warranty period.

Shipping an Item to Agilent for Service or Repair

If you wish to send an item from your system to Agilent Technologies for service or repair:

- Include a complete description of the service requested or of the failure and a description of any failed test and any error message.
- Ship the item using the original or comparable antistatic packaging materials.
- Contact Agilent for instructions on where to ship the item. Refer to “Contacting Agilent” on page 2-7.

Chapter 3: Installation and Operation

Information in This Chapter

Chapter Three at-a-Glance

Section Title	Summary of Content	Start Page
Front Panel Features	Descriptions of all front panel connectors, LEDs, and other items including the intended use for each.	Page 3-3
Rear Panel Features	Descriptions of all rear panel connectors including the intended use for each.	Page 3-5
Receiving the N5260A	Descriptions of the system components and Agilent custom engineering.	Page 3-7
Site Preparation	Descriptions of power requirements, environmental requirements, protections from ESD, and space requirements.	Page 3-9
PNA, Controller, and Millimeter-Wave Module Interconnections	Descriptions of rear panel cabling, front panel cabling, and the sequence of test head module connections.	Page 3-13
System Cable Connections	Descriptions of from/to connections for the E8361A network analyzer, the N5260A millimeter head controller, and the left and right test head modules	Page 3-16

Conventions Used for Hardkeys, Softkeys, and Menu Items

The following conventions are used in this document:

Hardkey

This represents a “hardkey”, a key that is physically located on the instrument.

Softkey

This represents a “softkey”, a key whose label is determined by the instrument firmware.

Menu Item

This represents an item in a drop-down or pop-up menu.

Front Panel Features

1. **Line Switch.** This switch turns the instrument ON or OFF. When the side of the switch labeled 0 is depressed, the instrument is OFF; when the side of the switch labeled 1 is depressed, the instrument is ON.
2. **Line LED.** This LED goes on or off with the instrument line switch to indicate the status of the line voltage applied to the instrument.
3. **S21, S11 LED.** This LED indicates that Port 1 is selected and the RF source is switched to Port 1. When the LED is off, Port 1 is terminated into 50 ohms inside of the N5260A millimeter head controller.
4. **S12, S22 LED.** This LED indicates that Port 2 is selected and the RF source is switched to Port 2. When the LED is off, Port 2 is terminated into 50 ohms inside of the N5260A millimeter head controller.
5. **RF OUT.** When the analyzer selects the port, an amplified RF source signal is available to a millimeter-wave head module at this connector.
6. **LO OUT.** This amplified LO signal is always available to the millimeter-wave head module.
7. **A IF.** This is the reflected IF signal input connection for S11 and the incident IF signal input connection for S12.
8. **R1 IF.** This is the reference IF signal input connection for S11 and S21.
9. **B IF.** This is the reflected IF signal input connection for S22 and the incident IF signal input connection for S21.
10. **R2 IF.** This is the reference IF signal input connection for S22 and S12.
11. **FUSE.** This is the bias fuse for port 1 or port 2.
12. **BIAS.** This bias supplies the +12.5 volts DC and ground lines to the millimeter wave head modules. Pins 1 and 3 are both +12.5 Vdc supplies. Pins 4 and 6 are the dc supply ground lines. Pins 2, 5, and 7 are unused.

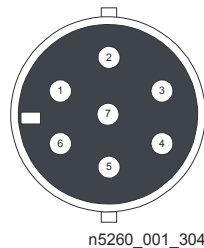

13. **Ground Lug**

Figure 3-1 N5260A Front Panel Features

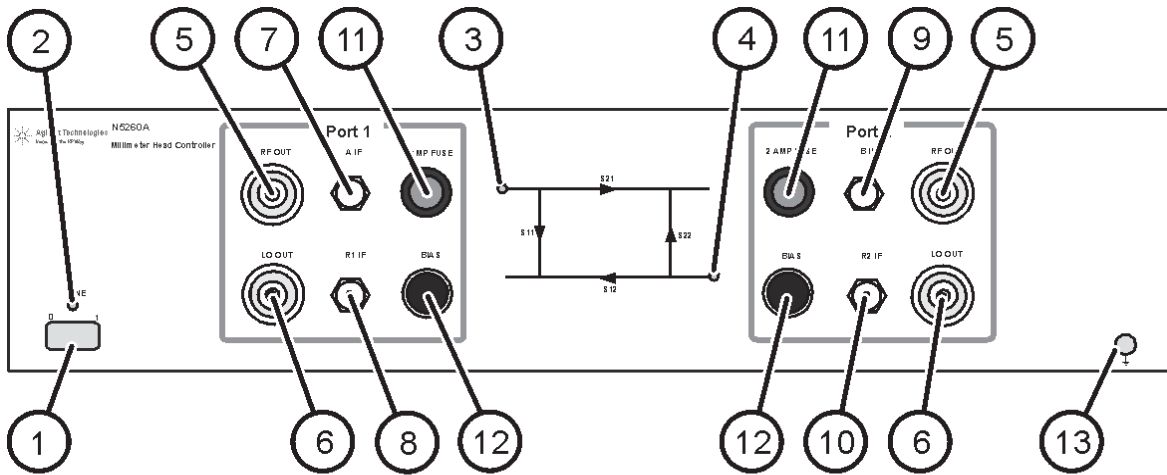

n5260_001_301

Rear Panel Features

1. **Line Module.** This assembly houses the line cord connection, line fuse, and line voltage selector. Pull out the topside of the line module cover to replace or change the fuse. Line voltage selection is automatic and no setting is required. Recommended fuse values are printed on the rear panel of the N5260A.

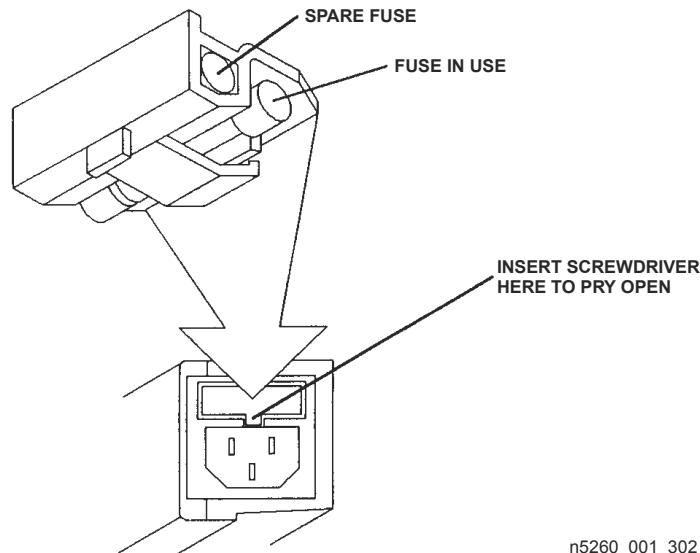

n5260_001_302

2. **LO Drive.** This input to the instrument comes from the LO drive of the PNA. The signal is split and amplified then output to the front panel of the N5260A.
3. **RF Drive.** This input to the instrument comes from the RF drive of the PNA. The signal is amplified then input to a switch that directs the RF to either Port 1 or Port 2 RF OUT on the front panel of the N5260A.
4. **A IF Output.** This connector transmits the IF signal from the test set to the PNA external A IF input.
5. **R1 IF Output.** This connector transmits the IF signal from the test set to the PNA external R1 IF input.
6. **R2 IF Output.** This connector transmits the IF signal from the test set to the PNA external R2 IF input.
7. **B IF Output.** This connector transmits the IF signal from the test set to the PNA external B IF input.
8. **Test Set Interface I/O.** This DB-25 female connector is used to transmit control signals from the PNA Test Set I/O.
9. **12 Volt Adjustment.** Access hole to adjust the 12-volt bias for the millimeter-wave head modules.
10. **Pulse.** Unused.

Figure 3-2 N5260A Rear Panel Features

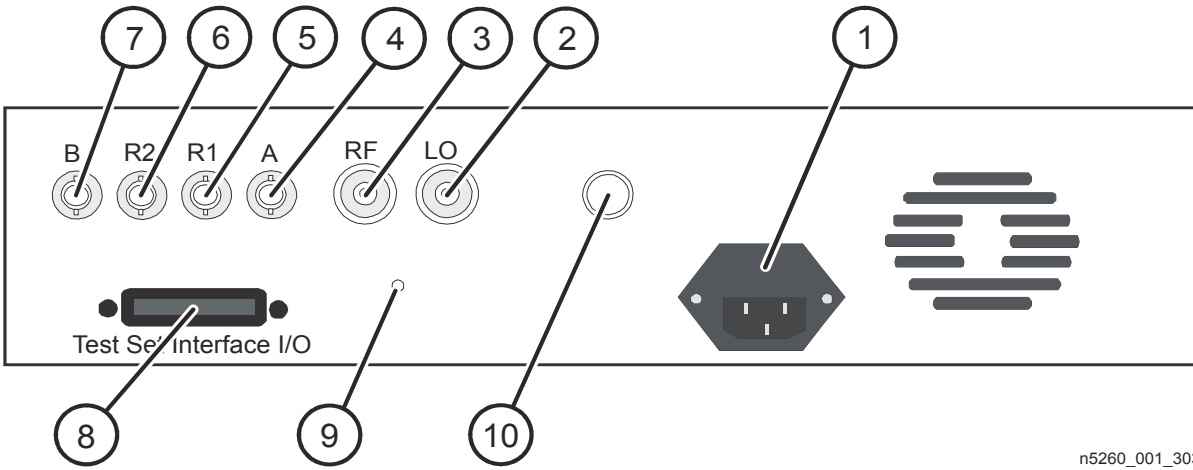

n5260_001_303

Receiving the N5260A

WARNING The N5260A millimeter head controller and the test head modules are sensitive to electrostatic discharge (ESD). Ground your work station before unpacking and installing the test head modules. See [“Electrostatic Discharge Protection” on page 1-5](#).

The N5260A as Shipped

The N5260A components will arrive packaged separately. For a list of components shipped with your N5260A, refer to [Table 3-1, “N5260A Contents,” on page 3-8](#).

Keep the shipping containers until the N5260A component checklist has been completed, and the components have been checked for physical damage.

If the shipping container is damaged or the packaging material shows signs of stress, notify the carrier as well as the Agilent Technologies Field Engineer. Keep the shipping materials for the carrier’s inspection. Agilent Technologies will arrange for repair or replacement of damaged equipment without waiting for a claim settlement from the carrier. Refer to [“Agilent Support, Services, and Assistance” on page 2-7](#).

System Contents

Use the table below to verify that the shipment is complete. These are items that are supplied with all N5250A/C complete systems only.

Table 3-1 N5260A Contents

✓	Agilent Part Number	Qty	Description
	N5260A	1	Millimeter Head Controller
	Includes:		
	85105-60030	2	Bias Cable
	85105-60033	4	IF Signal Cable
	8121-1221	4	RF and LO 3.5 mm Cable
	08503-60051	1	Test Set Interface Cable
	8120-1839	4	IF Signal Cable
	5061-9038	2	RF and LO SMA Cable
	1250-2604	4	SMA Right Angle Adapter (Not required unless needed with 8121-1221 cables.)
	5063-9226	1	Handle Set
	5063-9232	1	Rack Mount Flange Set
	N5260-90001	1	Installation and Service Guide

OML Millimeter Heads

If ordered from Agilent and included in the shipment container with the N5260A, each OML millimeter head is shipped with three pages of data: Power Curve, Dynamic Range, and Ref Port/Test Port. If this data is not included, contact OML at 408-779-2698 – provide your model and serial numbers and OML will fax the pages to you.

Site Preparation

Power Requirements

Before installing the PNA and N5260A, be sure that the required AC power is available at all necessary locations.

- Three-wire power cables (which provide a safety ground) must be used with all instruments.
- Air-conditioning equipment (or other motor-operated equipment) should not be placed on the same ac line that powers the system.
- The table below lists the maximum VA ratings and BTU/hour ratings for all instruments in the configuration. This table can be used to determine both the electrical requirements and the air conditioning requirements of the system.

Table 3-2 Power Requirements of a Standard Configuration

Standard Equipment		
Instrument	Maximum VA Rating	Maximum BTU/hour
PNA with Option H11	350	1195
N5260A millimeter head controller	320	1095
Millimeter-wave modules	(powered from controller)	(powered from controller)
Total	670	2290

Notes:

- (1) Values are based on 120 Vac supplied to each instrument at 60 Hz.
- (2) The N5260A millimeter head controller supplies power to the test head modules.

Environmental Requirements

The environmental requirements of the N5260A are listed in the table below. Note that these requirements are the same as those of the PNA network analyzer with Option H11.

NOTE Samples of this product have been type-tested in accordance with the Agilent Environmental Test Manual and verified to be robust against the environmental stresses of storage, transportation and end-use; those stresses include but are not limited to temperature, humidity, shock, vibration, altitude and power-line conditions. Test methods are aligned with IEC 60068-2 and levels are similar to MIL-PRF-28800F Class 3.

Table 3-3 Environmental Information

Parameter	Required Values/Ranges
Temperature	
Operating	5 °C to +40 °C
Storage	-40 °C to +70 °C
Altitude	
Operating	0 to 4,600 meters (^a 15,000 feet)

Heating and Cooling in the Operating Environment

Install air conditioning and heating, if necessary, to maintain the ambient temperature within the appropriate range (as given in the table above). Air conditioning capacity must be consistent with the BTU ratings given in [Table 3-2 on page 3-9](#).

Required Conditions for Accuracy Enhanced Measurement

Accuracy-enhanced (error-corrected) measurements require the ambient temperature of the N5260A to be maintained within ± 1 °C of the ambient temperature at calibration.

Protect Against Electrostatic Discharge (ESD)

This is important. If not properly protected against, electrostatic discharge can seriously damage your analyzer, resulting in costly repair.

CAUTION To reduce the chance of electrostatic discharge, follow all of the recommendations outlined in “[Electrostatic Discharge Protection](#)” on page 1-5.

Review the Principles of Connector Care

Proper connector care and connection techniques are critical for accurate and repeatable measurements. Refer to “[Principles of Connector Care](#)” on page 2-6 for tips on connector care.

Prior to making connections to your analyzer, carefully review the information about inspecting, cleaning, and gaging connectors. Refer to the calibration kit documentation for detailed connector care information.

Space Requirements

System Weight and Dimensions

- 55 kg (110 lb)
- Required Bench Top Dimensions for the configuration:
 - Clearance above bench top: 43 cm (17 in)
 - Width: 127 cm (50 in)
 - Depth: 102 cm (40 in)

Component Weight and Dimensions

Table 3-4 shows the maximum weight and dimensions of typical system components. Refer also to [Figure 3-3 on page 3-12](#) for test head module dimensions.

Table 3-4 Typical System Components Weights and Dimensions

Model	Weight	Height	Width	Depth
Millimeter-wave module (each)	3.5 kg (7.5 lb, ± 0.5 lb)	6.9 cm (2.7 in)	33.0 cm (12.9 in)	17.8 cm (6.9 in)
PNA with Option H11	29 Kg (64 lb) nominal	26.7 cm (10.5 in)	42.5 cm (16.7 in)	42.6 cm (16.8 in)
N5260A millimeter- head controller	9.1 Kg (20 lb)	9.0 cm (3.5 in)	42.4 cm (16.75 in)	49.5 cm (19.5 in)

Figure 3-3 Millimeter-Wave Module Dimensions for Mounting (typical OML model)

Mm-wave Module, Top View

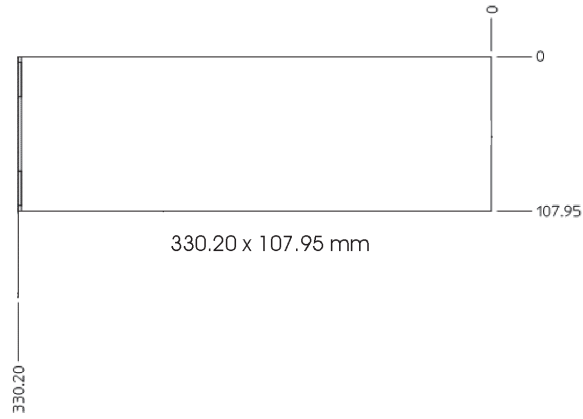

Front View

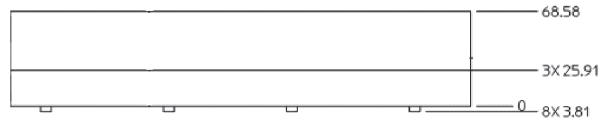

Bottom View

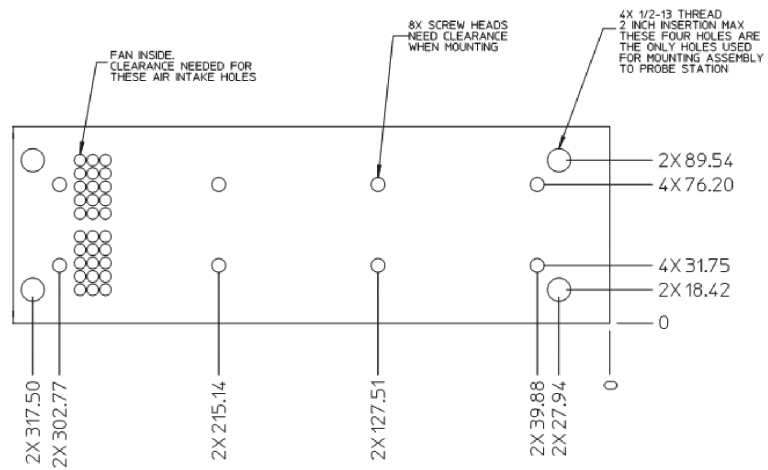

All dimension are in mm

N5260_001_313

PNA, Controller, and Millimeter-Wave Module Interconnections

Rear Panel Cabling

For the following instructions, it is assumed that PNA model E836xC is being used, unless noted otherwise.

Figure 3-4 shows the rear panel cabling. For front-panel cabling between the N5260A millimeter head controller and the modules, see “Front Panel Cabling” on page 3-14.

Figure 3-4 Rear View Cabling diagram

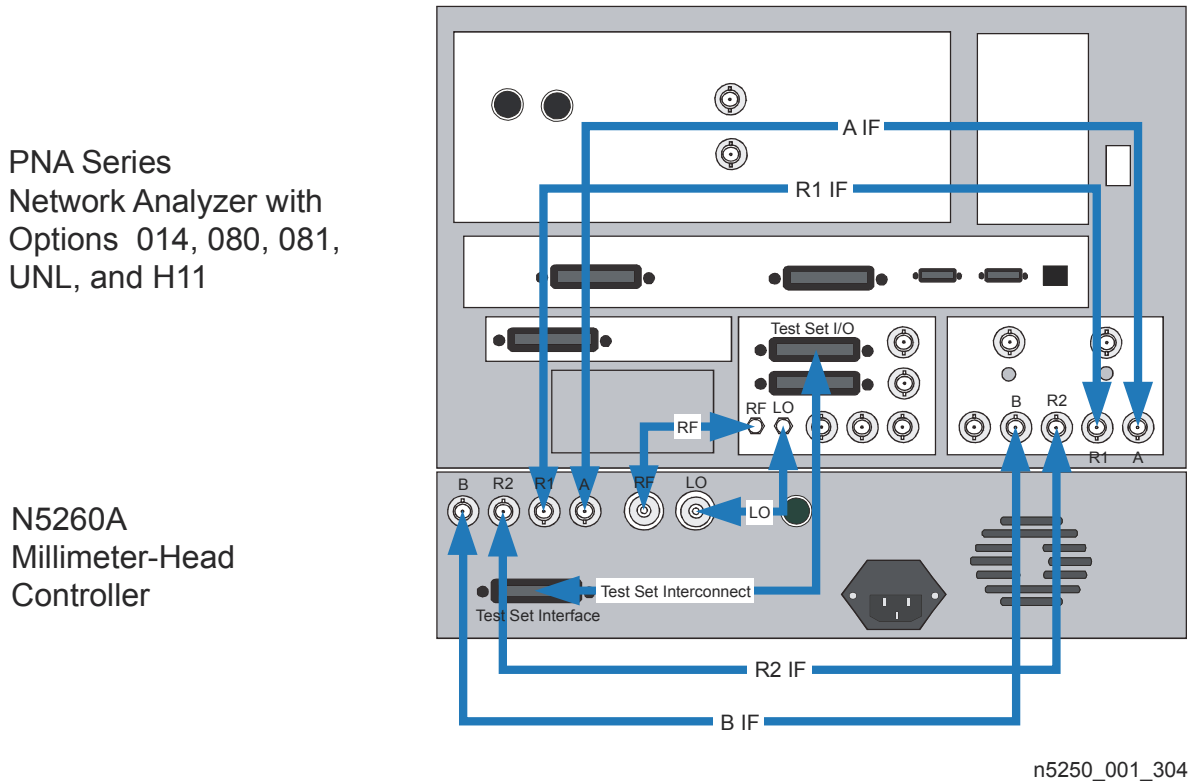

When an N5242A (PNA-X) is used, the following components (not included) must be used to modify the interconnect cabling shown above:

- Four SMA (m) to BNC (f) adapters (Agilent part number 1250-1200). The adapters are used to connect the IF signals from the N5260A to the PNA-X.
- One 10 dB attenuator (Agilent part number 0955-0122, or Model 8493C/D Option 010). See the following Caution statement.

CAUTION **N5242A (PNA-X) only:** A 10 dB attenuator (mentioned above) for the rear panel LO signal from the N5242A is required for protection of the N5260A LO input. This is important because the LO signal level from the N5242A rear panel LO output is high enough to damage the input amplifier inside the N5260A test set.

Front Panel Cabling

The front-panel interconnections between the N5260A millimeter head controller and the modules are shown in [Figure 3-5](#).

The test head modules are placed on the work surface in front of the PNA and head controller as shown. When the test head modules are facing each other like this, the Port 1 connector faces the Port 2 connector.

Refer to “[Sequence of Test Head Module Connections](#)” on page 3-15 for power supply connections to the test head modules.

NOTE The order in which cables are connected to a test head module is significant; see “[Sequence of Test Head Module Connections](#)” on page 3-15.

Figure 3-5 Interconnections of the Banded Solution for the N5260A

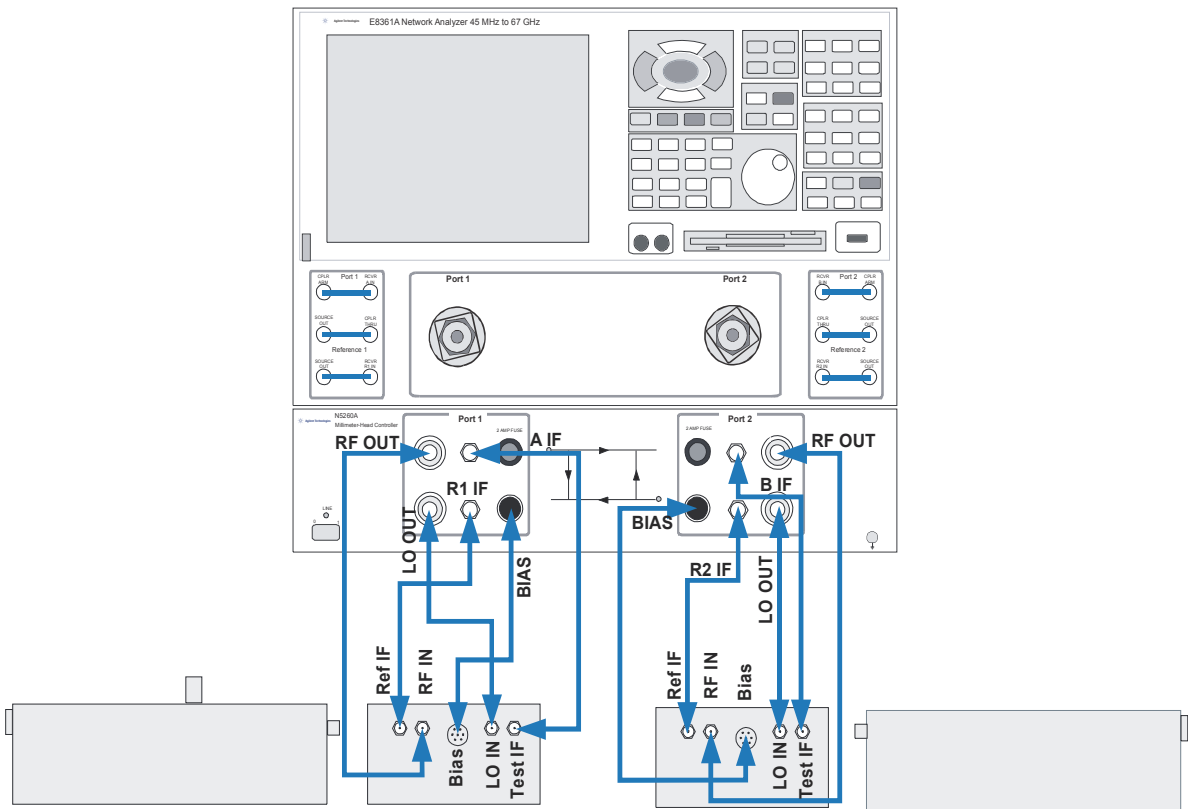

n5250_001_307

Sequence of Test Head Module Connections

NOTE Use a 57 N-cm (5 in-lb) torque wrench to tighten the SMA connectors and a 90 N-cm (8 in-lb) torque wrench to tighten the 3.5 mm connectors.

The connectors on the backs of the test head modules are very closely spaced. Attaching cables to these connectors is easiest if they are attached in the following sequence as illustrated in [Figure 3-6](#).

- ① BIAS; +12V @ 1.5A
- ② RF INPUT; SMA connector, 11.17–19.33 GHz @ +5 to +13 dBm
- ③ LO INPUT; SMA connector, 8.37–14.5 GHz @ +5 to +13 dBm
- ④ Ref IF; SMA connector
- ⑤ Test IF; SMA connector

Figure 3-6 Test Head Module Cabling Sequence

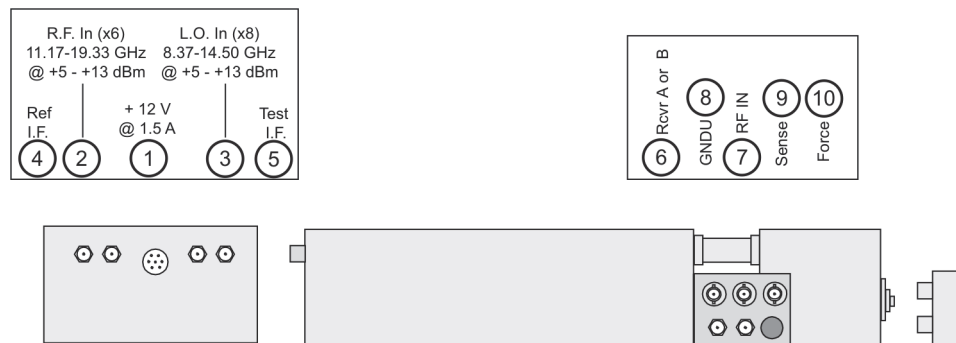

System Cable Connections

In this table, a complete from/to connection list is given for the E8361A network analyzer, the N5260A millimeter head controller, and the left and right test head modules. In other words, each cable is listed twice, and can be found by looking up the connection from either end. The duplicate listings make it easier to check the cabling after installation; if a cabling error is suspected.

Table 3-5 N5260A Cable List and Connections

From PNA Option H11 Network Analyzer:	To: N5260A Rear Panel	Cable Type	Part Number
Rear Panel:			
8.333 MHz IF Input A	N5260A–IF Output A	BNC	8120-1839
8.333 MHz IF Input R1	N5260A–IF Output R1	BNC	8120-1839
8.333 MHz IF Input R2	N5260A–IF Output R2	BNC	8120-1839
8.333 MHz IF Input B	N5260A–IF Output B	BNC	8120-1839
Test Set Drivers RF	N5260A–RF Drive	SMA	5061-9038
Test Set Drivers LO	N5260A–LO Drive	SMA	5061-9038
Test Set I/O	N5260A–Test Set Interface	Multi pin	08503-60051
From N5260A Millimeter Head Controller:	To: Millimeter Heads	Cable Type	Part Number
Front Panel:			
Bias (Port 1)	Bias (+12 V); N5260-60003 (Port 1)	Multi pin	85105-60030
A IF (Port 1)	Test IF; N5260-60003 (Port 1)	SMA	85105-60033
R1 IF (Port 1)	Ref IF; N5260-60003 (Port 1)	SMA	85105-60033
RF Out (Port 1)	RF In; N5260-60003 (Port 1)	3.5 mm	8121-1221
LO Out (Port 1)	LO In; N5260-60003 (Port 1)	3.5 mm	8121-1221
Bias (Port 2)	Bias (+12 V); N5260-60004 (Port 2)	Multi pin	85105-60030
R2 IF (Port 2)	Ref IF; N5260-60004 (Port 2)	SMA	85105-60033
B IF (Port 2)	Test IF; N5260-60004 (Port 2)	SMA	85105-60033
RF Out (Port 2)	RF In; N5260-60004 (Port 2)	3.5 mm	8121-1221
LO Out (Port 2)	LO In; N5260-60004 (Port 2)	3.5 mm	8121-1221

The cables listed above for connection to the millimeter heads are approximately *xx* inches long. Other cable sets of longer length are available by special order. Cable lengths up to a maximum of *yy* inches in length are generally supported.

Configuring the PNA Software for Banded Millimeter Head Operation

Instructions for configuring the PNA software for millimeter-wave modules are located in PNA Help. To access these instructions, click **Help > Network Analyzer Help**. Inside the Help program, click **PNA Applications > External (Banded) Millimeter Modules > How to Configure Millimeter Modules**.

After completing the configuration process, the PNA should display the expected start and stop frequencies.

Chapter 4: Operator's Check

Information in This Chapter

Chapter Four at-a-Glance

Section Title	Summary of Content	Start Page
System Operation Check	Description of the operator's check.	Page 4-3

Conventions Used for Hardkeys, Softkeys, and Menu Items

The following conventions are used in this document:

Hardkey

This represents a "hardkey", a key that is physically located on the instrument.

Softkey

This represents a "softkey", a key whose label is determined by the instrument firmware.

Menu Item

This represents an item in a drop-down or pop-up menu.

System Operation Check

The operator's check procedure confirms that the banded millimeter wave system functions normally. There are no hard specifications for the system measurement performance, only general guidelines are provided for evaluating the operator's check results.

Technical judgment is required when evaluating the results. The purpose of the operator's check is to detect significant degradations in the system that make the performance unacceptable. The calibration kit and test environment can affect the operation check results. Refer to "Site Preparation" on page 3-9 and Table 3-3, "Environmental Information," on page 3-10.

When any part of the operator's check provides unsatisfactory results, troubleshoot the system to determine the cause of the problem.

Long Term Storage of Test Results

It is recommended that you store results from the Operator's Check procedures for future reference. Prior results can be useful when evaluating changes in system performance. After completing a successful section that accurately represents the system performance, store the test result files in the directory **D:\opcheck results**. It may be necessary to create this directory if it does not already exist.

To capture the PNA display in a file, select: **File > Print > Print to file...** File names should contain the following: the measurement, the millimeter wave head serial number for each port, and the date. An example of a recommended file name is "initial_p1-71213-1_p2-71213-2_Oct_18_2011.png".

Required Equipment

- A calibration kit compatible with the millimeter wave heads.
- Two waveguide extension sections (provided as accessories for the millimeter wave heads or as part of a calibration kit).

Information Required for the Operator's Check

- From the data pages provided by OML for individual millimeter wave heads:
 - Reference the Dynamic Range and Ref Port/Test Port pages for each OML millimeter wave head for use in the operator's check process defined below.

NOTE OML ships three pages of data with each millimeter wave head: Power curve, Dynamic Range, and Ref Port/Test Port. If this data has been lost, contact OML at 408-779-2698 or info@omlinc.com. Provide your model, serial numbers and fax number. OML will fax the pages to you.

Preparing the System

See “PNA, Controller, and Millimeter-Wave Module Interconnections” on page 3-13 and “Configuring the PNA Software for Banded Millimeter Head Operation” on page 3-17.

Attach a waveguide extension to the port on each module.

Calibration Kit

An appropriate waveguide calibration kit - manufactured by Agilent or another company - is required for the operator's check. The Agilent calibration kit definition is included with the PNA firmware. If a calibration kit from a company other than Agilent is used with the millimeter wave heads, the calibration kit definition must be entered into the PNA. To enter it, use the PNA function “Import Cal Kit” to import the .ckt file from a floppy disk or USB pen drive. (Search the PNA Help index for the keywords “modify calibration kit” for instructions.) Include the calibration kit serial number in the calibration kit definition name/description.

Operator's Check Procedure

The operator's check has three sections:

- Initial Check (steps 1-1 through 1-5)
- Dynamic Range Check (steps 2-1 through 2-17)
- Calibration Check (steps 3-1 through 3-4)

Initial Check

This procedure verifies that the system is connected correctly and the modules, test set and PNA are operating properly.

- 1-1. Allow the system to warm up for at least 30 minutes.
- 1-2. Attach a waveguide extension section to each module's waveguide flange port.
- 1-3. Verify that the PNA is in Millimeter Mode and displaying the appropriate frequency range for the millimeter wave heads.
- 1-4. Press [**Preset**].
- 1-5. To verify the port as a receiver, perform the following steps:
 - a. Connect a short to module Port 1.
 - b. Press [**Avg**] > [**IF Bandwidth**] > [**100**] > [**Enter**].
 - c. Display all receivers on the PNA screen using the following menu selections: [**System**] > [**Service**] > [**Utilities**] > [**Receiver Display**].
 - d. Compare the A,1 and R1,1 traces to the traces on the RefPort/TestPort page from OML for the millimeter wave head on Port 1. The general level and shape should be similar but not necessarily identical.
 - e. Move the short to module Port 2.
 - f. Compare the B,2 and R2, 2 traces to the traces on the RefPort/TestPort page from OML for the millimeter wave head on Port 2. The general level and shape should be similar, but not necessarily identical.

When you have a display that represents the current system performance, capture the display in a file and save the file in the directory **D:\opcheck results** (create this directory if it does not already exist). See “[Long Term Storage of Test Results](#)” on page 4-3 for details on saving test results.

Dynamic Range Check

This procedure checks uncorrected through measurements and the dynamic range of each millimeter wave head.

- 2-1. Connect the waveguide extension flanges of Port 1 to Port 2 to form a through connection. Adjust the feet on the modules to insure the mating surfaces are properly aligned before connecting the waveguide flanges.
- 2-2. Press **[Preset]**.
- 2-3. Press **[Avg] > IF Bandwidth [100] > Enter**.
- 2-4. Delete the S_{11} trace by pressing **Trace/Chan > Trace > Delete Trace**.
- 2-5. Press **Trace/Chan > Trace > New Trace**.
- 2-6. Select S_{12} and S_{21} . Both traces should be within approximately 10 dB of zero.
- 2-7. When you have a display that represents the current system performance, capture the display in a file and save the file in the directory **D:\opcheck results**. See “[Long Term Storage of Test Results](#)” on page 4-3 for details on saving test results.
- 2-8. Set the PNA for 10 Hz IF Bandwidth by pressing **[Avg] > IF Bandwidth [10] > Enter**.
- 2-9. Verify that both module's ports are connected together to form a through connection.
- 2-10. Select each trace and normalize it by pressing **[Memory] > Normalize**.
- 2-11. Select each trace and adjust its reference level by pressing **[Scale] > Reference Level [-80] > Enter**.
- 2-12. Disconnect the through connection.
- 2-13. Connect a load to module Port 1.
- 2-14. Compare the S_{12} trace to the dynamic range for the OML millimeter wave head. The PNA trace should be no more than 10 dB above the OML dynamic range trace.
- 2-15. When you have a display that represents the current system performance, capture the display in a file and save the file in the directory **D:\opcheck results**. See “[Long Term Storage of Test Results](#)” on page 4-3 for details on saving test results.
- 2-16. Connect a load to module Port 2.
- 2-17. Compare the S_{21} trace to the dynamic range data for the OML millimeter wave head. The PNA trace should be no more than 10 dB above the OML dynamic range trace.
- 2-18. When you have a display that represents the current system performance, capture the display in a file and save the file in the directory **D:\opcheck results** (create this directory if it does not already exist). See “[Long Term Storage of Test Results](#)” on page 4-3 for details on saving test results.

NOTE If testing a single millimeter wave head stand-alone, connect a short in place of the through connection, then disconnect the Test IF cable from the module for the dynamic range measurement.

Chapter 5: System Troubleshooting and Repair

Information in This Chapter

Chapter Four at-a-Glance

Section Title	Summary of Content	Start Page
Troubleshooting	A troubleshooting flowchart and associated procedures to isolate problems to a faulty part or assembly.	Page 5-3
System Repair and Calibration	Information on repair and calibration services for individual system components.	Page 5-11

Conventions Used for Hardkeys, Softkeys, and Menu Items

The following conventions are used in this document:

Hardkey

This represents a “hardkey”, a key that is physically located on the instrument.

Softkey

This represents a “softkey”, a key whose label is determined by the instrument firmware.

Menu Item

This represents an item in a drop-down or pop-up menu.

Troubleshooting

The troubleshooting strategy for the N5260A millimeter head controller is systematic. This information is used after system level troubleshooting has identified the N5260A as the problem instrument.

Use the troubleshooting flowchart on the following page to identify the faulty assembly. The flowchart is keyed to numbered individual troubleshooting procedures. As you progress through the flowchart, perform the numbered procedure associated with each block.

A block diagram is provided in [Chapter 6 \(Figure 6-1 on page 6-6\)](#) to assist in understanding the operation of the N5260A millimeter head controller.

Equipment Required but not Supplied

You need the following equipment to troubleshoot your instrument. This equipment is not supplied as part of your product shipment.

- E4417A power meter or equivalent
- 8485A power sensor or equivalent
- 10-dB attenuator (for power sensor)
- Digital multi-meter (DMM)
- T-10 Torx driver

Troubleshooting Flowchart

[Figure 5-1](#) is a flowchart illustrating the recommended procedure for determining a failure in the N5260A.

Figure 5-1 N5260A Troubleshooting Flowchart

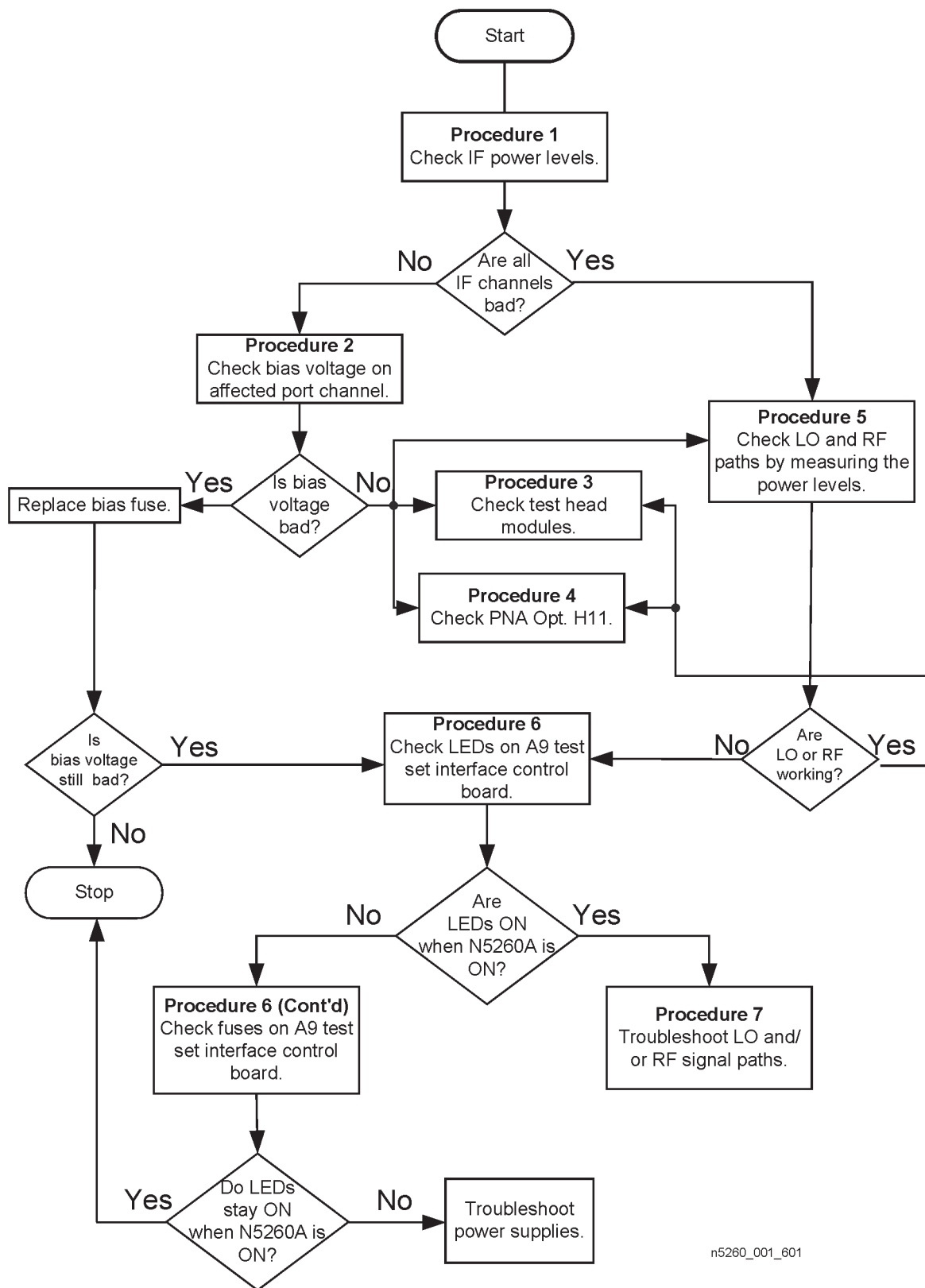

n5260_001_601

Troubleshooting Procedures

Procedure 1: Check IF Power Levels

- Interconnect the measurement system components as shown in Figure 5-2.

Figure 5-2 Procedure 1 System Connections

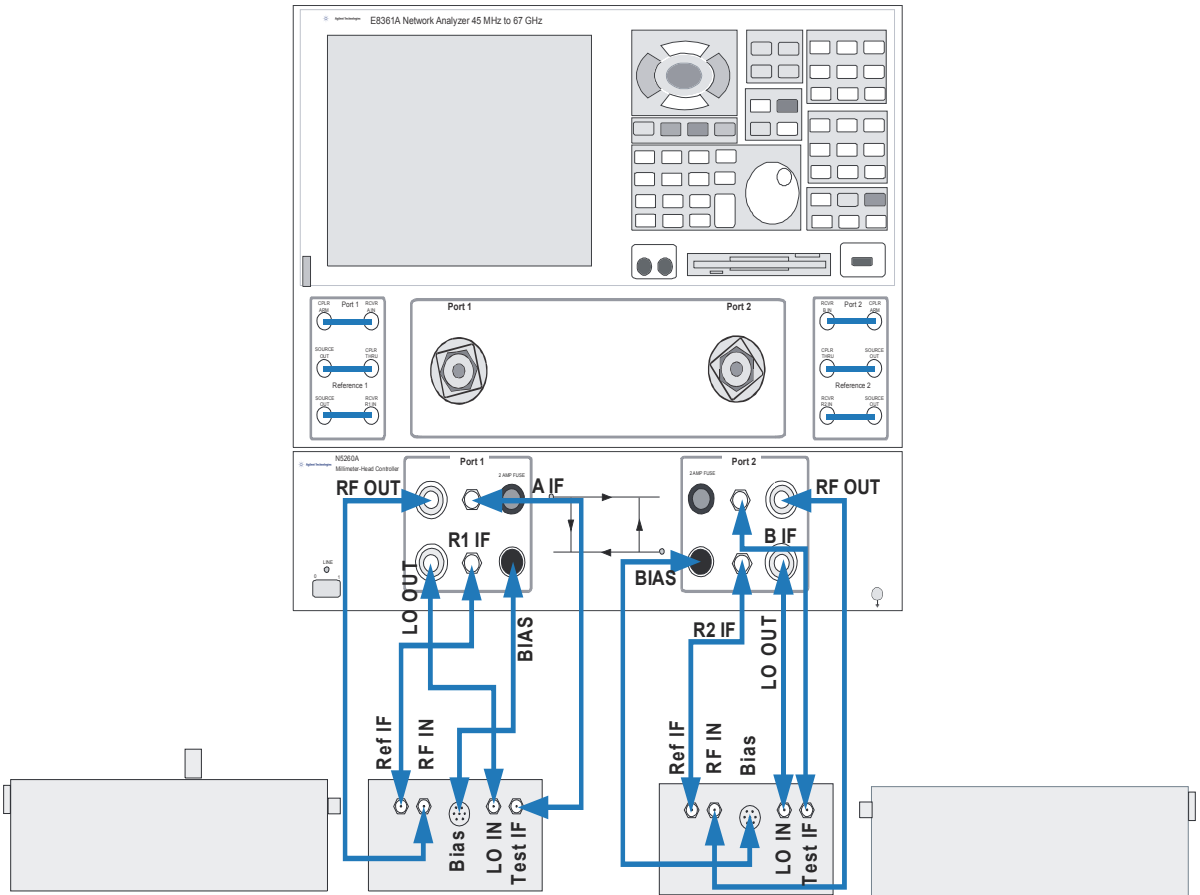

n5250_001_307

- Install short(s) on Port 1 and Port 2.
- Restart the network analyzer application on the PNA Option H11 and perform a factory preset by pressing the **PRESET** key.
- On the PNA, set the IF bandwidth to 1 kHz.
- On the PNA:
 - Without softkeys: On the menu bar, select: **System > Service > Utilities > Receiver Display**.
 - With softkeys: Select: Press UTILITY **System**, then **Service**, then **Utilities**, then **Receiver Display**.

6. The traces in the PNA receiver display should be similar to those shown in [Figure 5-3](#).

Figure 5-3 Procedure 1 Typical Receiver Display

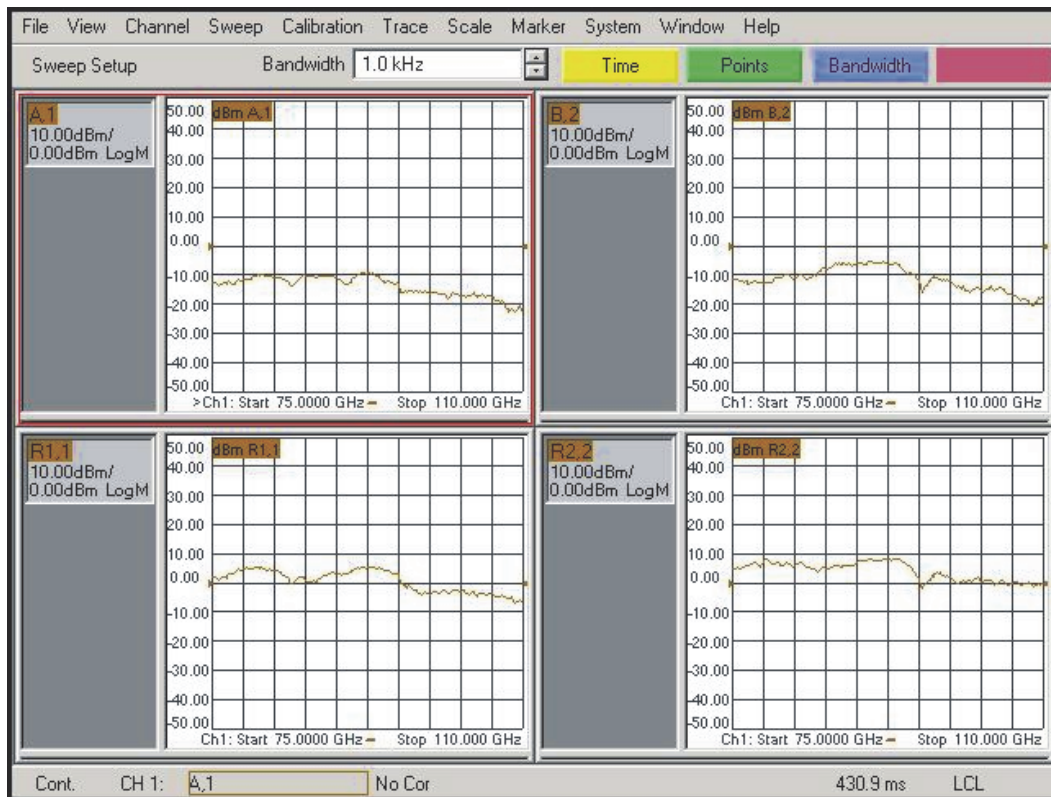

N5260_001_313

7. If there are power holes, examine the system for loose or damaged cables, dirty or damaged connectors, proper connector torque, etc.
8. If one or all of the IF traces are not displayed, check to ensure that all interconnections from the N5260A millimeter head controller to the test heads are properly connected.
9. If one or more (but not all) IF traces are still missing, go to [“Procedure 2: Check the Bias Voltage on Affected Port\(s\)”](#).
10. If all of the IF traces are still missing, go to [“Procedure 5: Check the N5260A LO and RF Paths”](#).

Procedure 2: Check the Bias Voltage on Affected Port(s)

The pins used on the bias connectors for ports 1 and 2 are described below. Pins 2, 5, and 7 are not used.

- Pins 1 and 3 +12.5 Vdc
- Pins 4 and 6 DC ground

Figure 5-4 Procedure 2 Bias Supply Connectors

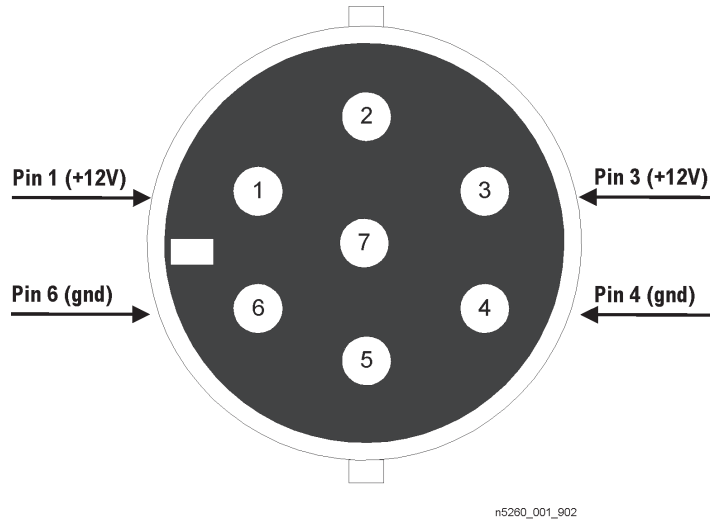

1. Measure the voltage at each of the pins on the bias connectors. The measured results should be approximately as noted above.
2. If the +12.5 V is not present on pins 1 and 3, replace the front panel bias fuse and measure again. If the +12.5 V is still not present, go to [“Procedure 3: Check the Test Head Modules”](#). NOTE: If the front panel bias fuse is not the cause of the problem, check the internal +15V fuse - see [Figure 7-15 on page 7-33](#).
3. If the +12.5 V is present, reconnect the bias cable and measure pins 1 and 3 at the other end of the cable.
4. If the +12.5 V is not present, replace the cable. If the +12.5 V is present, go to [“Procedure 3: Check the Test Head Modules”](#).

Procedure 3: Check the Test Head Modules

1. Swap the left and right test head modules in the system setup. The left test head module should now connect to Port 2 and the right test head module should connect to Port 1.
2. Repeat Procedure 1 with the test head modules reversed in this manner.
3. If the problem with the affected IF trace follows the test head module, replace the test head module.
4. If the problem with the affected IF trace does not follow the test head module, go to [“Procedure 4: Check the PNA Option H11”](#).

Procedure 4: Check the PNA Option H11

The service program to check PNA Option H11 operation is built into the PNA firmware. Use the following steps to access the service program.

On the PNA:

- Without softkeys: On the menu bar, select: **System > Service > Rear Panel/H11 Test**.
- With softkeys: Select: Press UTILITY **System** , then **Service** , then **More** , then **Rear Panel/H11** .

Once the program starts, click on the Configure tab and deselect the External Pulse Input tests. These tests are not needed for the basic Option H11 testing. The external pulse inputs are only used for pulse measurements.

Perform the following tests:

- RF & LO Power
- External IF Input
- Test Set I/O

Refer to the PNA Service Guide for troubleshooting and repair of the PNA Option H11 components.

Procedure 5: Check the N5260A LO and RF Paths

1. Disconnect the cables from the test head RF and LO inputs.
2. Connect a 3.5 mm (26.5 GHz) power meter/power sensor/10-dB pad to the end of the cable from each of the N5260A RF and LO ports. The power meter/power sensor must be capable of measuring a signal level of +7 to +13 dBm at 7 to 19 GHz.
 - a. Put the PNA into mm-wave mode with the millimeter heads connected.
 - b. Preset the PNA.
 - c. Set the PNA to CW sweep mode at the lowest frequency of the millimeter band with a long sweep time, 1 kHz IF bandwidth, and S_{11} trace.
 - d. Measure the power levels using the power meter/power sensor. The power level for the RF and LO should be between +7 and +13 dBm.
 - e. Switch the trace to S_{22} . Measure the power level at the end of the RF and LO cables where they connect to the port 2 millimeter head. The power level for the RF and LO should be between +7 and +13 dBm.
 - f. Repeat steps “d” and “e” above for the highest frequency of the millimeter band.
3. If the RF and LO signals are at the proper power level, go to “[Procedure 3: Check the Test Head Modules](#)”.
4. If the RF and LO signals are not at the proper level, go to “[Procedure 6: Check the Power Supplies LEDs and Fuses](#)”.

Procedure 6: Check the Power Supplies LEDs and Fuses

WARNING These servicing instructions are for use by qualified personnel only. To avoid electrical shock, do not perform any servicing unless you are qualified to do so.

WARNING Procedures described in this document are performed with power supplied to the product while protective covers are removed. Energy available at many points may, if contacted, result in personal injury.

1. Remove the outer cover from the N5260A as described in “Removing and Replacing External Parts” on page 7-5.
2. Re-connect ac power to the N5260A with the cover off. Be extremely careful as dangerous voltages are exposed.
3. Visually inspect the LEDs identified in Figure 5-5. All of the LEDs should be lit.

Figure 5-5 LED and Fuse Locations on the A9 Test Set Interface Control Board

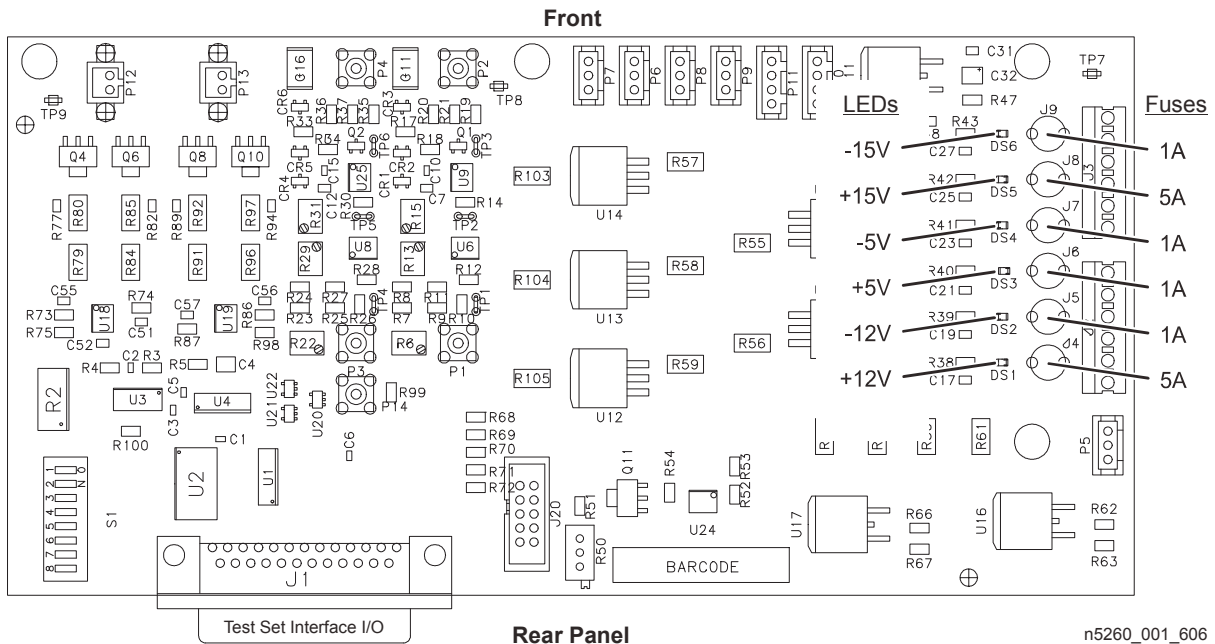

4. If all of the LEDs are lit, go to “Procedure 7: Check LO and/or RF Signal Paths”.
5. If any LED is not lit:
 - Remove ac power from the N5260A and wait 10 seconds for capacitors to discharge.
 - Remove the fuse associated with any LED that was not lit. Refer to Figure 5-5. Visually inspect the fuse and measure it (with a DMM) for continuity.
 - Replace any damaged or “blown” fuses.
6. If the problem still persists after checking and replacing fuses, troubleshoot the A1 and A21 power supplies.

Procedure 7: Check LO and/or RF Signal Paths

Refer to [Figure 6-1 on page 6-6](#). Troubleshoot by tracing the RF and/or LO paths through the test set, from the front panel to the rear panel. Replace defective assemblies as necessary.

System Repair and Calibration

Agilent Technologies provides repair and calibration services for the following individual system components, unless otherwise noted.

System Component	Manufactured by:		Repair Services	Calibration Services
	Agilent Technologies	Vendor		
PNA/PNA-X	✓	--	✓	✓
N5260A Test Set	✓	--	✓	N/A
mmWave Modules (Heads)	--	✓	✓ ^a	N/A
Waveguide Calibration Kits	✓	✓	✓ ^b	✓ ^b

- a. Repair of vendor products is coordinated by Agilent, but performed by vendor. Expected repair time is six weeks because of part availability.
- b. Repair and calibration of vendor products is coordinated by Agilent, but performed by vendor. Expected repair time is eighteen weeks because of part availability.

Part II: Test Set Service

Part II of this manual covers service-related information for the N5260A test set.

Chapter 6, "Specifications and Theory of Operation"	
Specifications	Specifications and typical characteristics for your N5260A.
Theory of Operation	<p>A general description of how the N5260A works including an overall block diagram.</p> <p>Detailed descriptions of each functional area:</p> <ul style="list-style-type: none"> • RF Section • LO Section • Input and Output Connectors • Test Set Interface • Test Set Interface Control Board
Chapter 7, "Test Set Repair"	
Personal Safety Warnings	Warnings and cautions pertaining to personal safety.
Protect Against Electrostatic Discharge (ESD)	Information pertaining to ESD protection.
Repair	Procedures outlining how to remove and replace faulty parts and assemblies.
Chapter 8, "Replaceable Parts"	
Ordering Information	How to order a replaceable part from Agilent Technologies.
Replaceable Parts	<p>Tables that list the assemblies by reference designator with their associated part number and description.</p> <p>Illustrations that indicate the location of each of the replaceable parts in your N5260A.</p>
Chapter 9, "Test Set Adjustments and Tests"	
Adjustment Procedures	<p>The definition of a rebuilt-exchange assembly.</p> <p>The procedure for replacing and returning a defective assembly to Agilent Technologies.</p>

Chapter 6: Specifications and Theory of Operation

Information in This Chapter

Chapter Five at-a-Glance

Section Title	Summary of Content	Start Page
Specifications	Specifications and typical characteristics for your N5260A millimeter head controller.	Page 6-3
Theory of Operation	A general description of how the N5260A millimeter head controller works including an overall block diagram. Detailed descriptions of each functional area: <ul style="list-style-type: none">• RF Section• LO Section• Input and Output Connectors• Test Set Interface	Page 6-5

Specifications

Specifications described here are the typical performance of the N5260A millimeter head controller. For the electrical specifications of the N5260A millimeter head controller when used in the N5250A/C system, see the N5250A/C Installation and Service Guide. If a printed version of the N5260A manual is not available, refer to “[Printing Copies of Documentation from the Web](#)” on page iii of this manual.

There are no specifications or typical specifications for the PNA + N5260A + OML banded millimeter wave configuration. There are some limited typical specifications for the OML millimeter wave modules which can be found on the OML website (<http://www.omlinc.com>). The only two OML typical specifications that apply for the field to perform are dynamic range and coupler directivity.

Supplemental Characteristics

The supplemental characteristics provide information useful in applying the instrument by giving typical, but non-warranted, performance parameters.

Table 6-1 N5260A Supplemental Characteristics

Test Ports (Front Panel)		
RF connector type:	Precision 3.5 mm female	
LO connector type:	Precision 3.5 mm female	
A, R1, R2, B connector type:	SMA female	
Connector torque:	90N-cm (8 in-lb)	
Other Connectors (Rear Panel)		
RF drive connector type:	Precision 3.5 mm female	
LO drive connector type:	Precision 3.5 mm female	
A, R1, R2, B connector type:	BNC 50-ohm female	
Connector torque:	90N-cm (8 in-lb)	
Nominal Operating Power Level		
Operating Level	Port 1	Port 2
RF 1.7 to 20 GHz	+12 to +7 dBm	+12 to +7 dBm
LO 1.7 to 20 GHz	+12 to +7 dBm	+12 to +7 dBm
RF Source Power Level		
Damage input level:	+6 dBm	
Maximum input level:	+5 dBm	
Minimum input level:	-16 dbm	

Table 6-1 N5260A Supplemental Characteristics

LO Source Power Level	
Damage input level:	+6 dBm
Maximum input level:	+5 dBm
Minimum input level:	-16 dbm

Power Requirements and Physical Characteristics

Operating temperature:	5° C to 40° C (41° F to 104° F)
Power:	110/115/230/240 V 50/60 Hz 60W
Dimensions:	90 mm X 425 mm X 49 5mm (3.5 in X 16.75 in X 19.5 in)
Weight:	9.1 kg (20 lb.)

Theory of Operation

Refer to the block diagram in [Figure 6-1](#) for the following paragraphs.

RF Section

The RF drive signal enters the rear panel of the N5260A millimeter head controller and is routed through two amplifiers (A8 and A6) and a PIN switch (A14). The PIN switch routes the signal to either Port 1 or Port 2 depending on the system configuration and stimulus signal need for each S-parameter measurement.

Internal leveling for the RF signal is provided by the A10 coupler and A13 detector output. The RF signal power output is adjusted and leveled by the RF ALC circuit feed back to the second stage modulator amplifier. The ALC circuit in the RF amplifier section (located on the A9 test set interface control board) provides a relatively constant RF drive for both ports 1 and 2.

RF signal gain through the millimeter head controller is >25 dB from 2 to 20 GHz. Typical RF drive power at the front panel ports is between +7 and +13 dBm for the 7 to 19 GHz required by the millimeter-wave test heads.

LO Section

The LO drive signal enters the rear panel of the N5260A millimeter head controller and is routed through two amplifiers (A3 and A5) and a power divider (A19).

Internal leveling for the LO signal is provided by the A16 coupler and A18 detector output. The LO signal power output is adjusted and leveled by the LO ALC circuit feed back to the second stage modulator amplifier. The ALC circuit in the LO amplifier section (located on the A9 test set interface control board) provides a relatively constant LO drive for both ports 1 and 2.

Isolators are added to the individual LO ports to increase the isolation between port 1 and 2 LO paths. The isolators are banded and limit the output frequency to 8 to 18 GHz.

Typical LO drive power at the front panel ports is between +7 and +13 dBm for the 7 to 19 GHz required by the millimeter-wave test heads.

Input and Output Connectors

The four front panel IF connectors (A, R1, R2, B) receive the reference and test signals from the port 1 and 2 millimeter-wave test head modules. The signals pass directly through the millimeter head controller and are routed to the microwave PNA series analyzer IF multiplexer board. The IF signal is 8.333 MHz and has a maximum input level of -27 dBm

The port 1 and 2 BIAS connectors supply +12 volts DC at up to 2 amps each. This bias supply is sufficient to power the millimeter-wave test heads supported for the microwave PNA series analyzers with the IF access option, Option H11.

Test Set Interface

The N5260A is controlled by the PNA via the Test Set Interface I/O connector. The PNA controls the RF signal to either port 1 or port 2 depending on the system configuration and stimulus signal need for each S-parameter measurement.

The S-parameter LEDs will light and indicate which RF OUT port of the millimeter head controller is active. When both LEDs are off, the RF OUT ports are terminated and the millimeter head controller is disabled.

Figure 6-1 N5260A Block Diagram

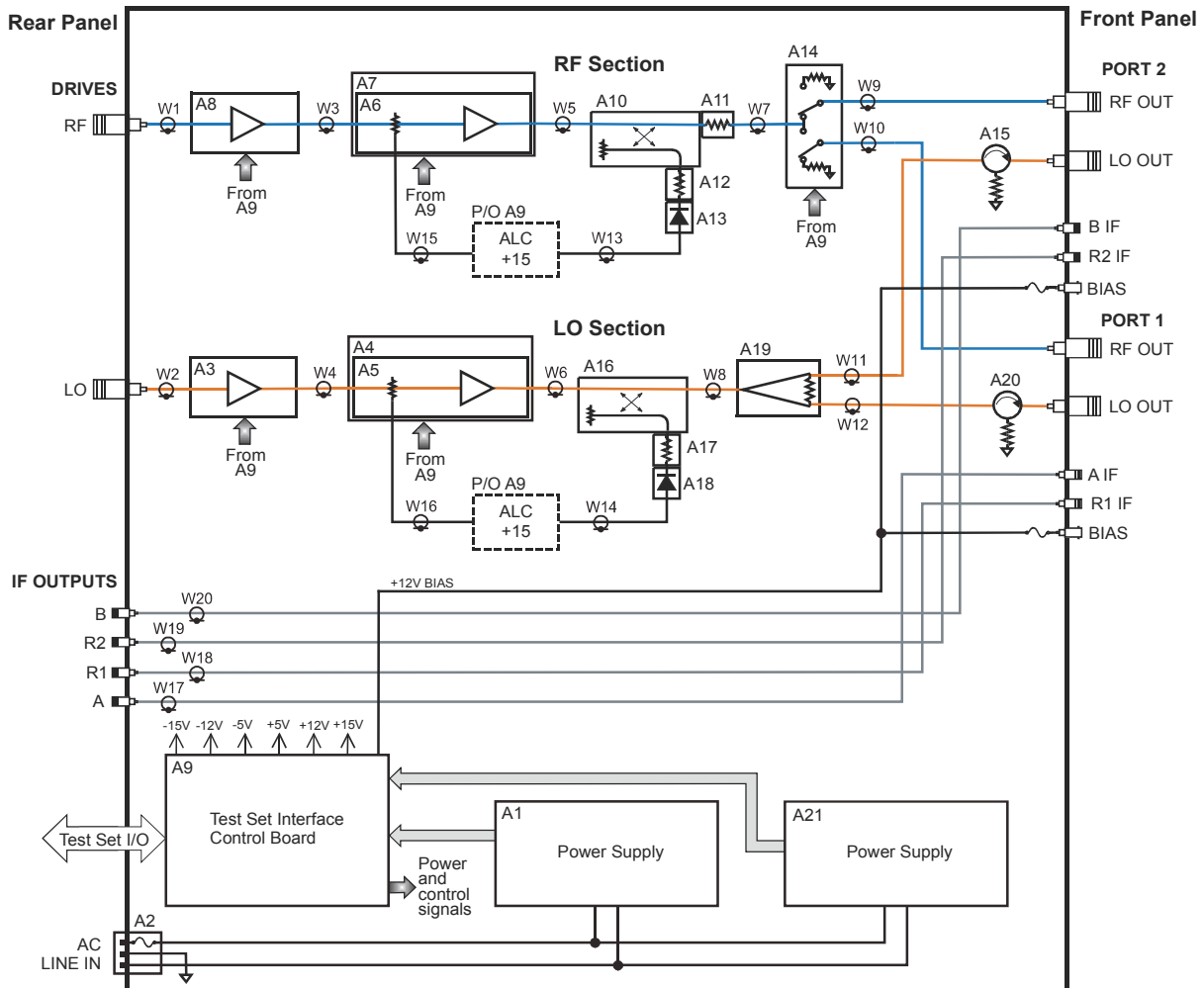

n5260_001_501

Chapter 7: Test Set Repair

Information in This Chapter

This chapter contains procedures for troubleshooting your Agilent Technologies N5260A millimeter head controller and then removing and replacing the faulty parts and assemblies.

Chapter Six at-a-Glance

Section Title	Summary of Content	Start Page
Personal Safety Warnings	Warnings and cautions pertaining to personal safety.	Page 7-3
Protect Against Electrostatic Discharge (ESD)	Information pertaining to ESD protection.	Page 7-3
Repair	Procedures outlining how to remove and replace faulty parts and assemblies.	Page 7-4

Personal Safety Warnings

WARNING These servicing instructions are for use by qualified personnel only. To avoid electrical shock, do not perform any servicing unless you are qualified to do so.

WARNING The opening of covers or removal of parts is likely to expose dangerous voltages. Disconnect the product from all voltage sources while it is being opened.

WARNING Procedures described in this document may be performed with power supplied to the product while protective covers are removed. Energy available at many points may, if contacted, result in personal injury.

WARNING The power cord is connected to internal capacitors that may remain live for 10 seconds after disconnecting the plug from its power supply assembly. Wait at least 10 seconds, after disconnecting the plug, before removing the covers.

Protect Against Electrostatic Discharge (ESD)

This is very important. If not properly protected against, electrostatic discharge can seriously damage your analyzer, resulting in costly repair.

CAUTION To reduce the chance of electrostatic discharge, follow all of the recommendations outlined in [“Electrostatic Discharge Protection” on page 1-5.](#)

Repair

This section contains procedures for removing and replacing faulty parts and assemblies. Included are procedures for:

- Removing and Replacing External Parts
- Removing and Replacing Front Panel Parts
- Removing and Replacing the A1 and A21 Power Supply Boards
- Removing and Replacing the A3 and A8 Buffer Amplifiers
- Removing and Replacing the A4 and A7 Modulator/Amplifiers and the A5 and A6 Bias Boards
- Removing and Replacing the A9 Test Set Interface Control Board
- Removing and Replacing the A10 and A16 Couplers
- Removing and Replacing the A11, A12 and A17 Attenuators and the A13 and A18 Detectors
- Removing and Replacing the A14 RF Switch
- Removing and Replacing the A15 and A20 Isolators
- Removing and Replacing the Fan
- Removing and Replacing the A2 AC Line Module and Line Fuse

Removing and Replacing External Parts

Tools Required

- T-15 TORX driver (set to 9 in-lb)
- T-20 TORX driver (set to 21 in-lb)

Removing the Top or Bottom Cover

1. Disconnect the power cord.
2. Position the instrument so that the cover you plan to remove is facing up.
3. With a T-15 TORX driver, loosen the screw in both of the rear panel stand-offs next to the cover, and then lift off the stand-offs.
4. With a T-15 TORX driver, loosen the screw in the middle of the cover.
5. Slide the cover off of the chassis.

Removing the Side Covers

1. To remove the side cover with the strap handle:
 - With a T-20 TORX driver, remove the two screws located in the strap handle retainer.
 - Lift off the handle.
 - Slide the cover off of the chassis.
2. The perforated side cover has no screws, so to remove it, simply slide it off of the chassis.

Replacement Procedure

Reverse the order of the removal procedures.

Removing and Replacing Front Panel Parts

Tools Required

- T-10 TORX driver (set to 9 in-lb)
- 5/16 inch open-end torque wrench (set to 10 in-lb)
- Soldering iron and solder
- ESD grounding wrist strap

Removal Procedure

Refer to [Figure 7-1](#) and [Figure 7-2](#) for this procedure.

1. Disconnect the power cord.
2. Remove the top cover. Refer to “[Removing and Replacing External Parts](#)” on page 7-5.
3. To remove the front dress panel and the front sub-panel, all front panel components must first be removed.
4. To remove the front panel RF connectors and ground lug:
 - a. Remove all RF cables from all front panel RF connectors.
 - b. Remove all hardware (hex nuts and washers) from all front panel RF connectors and the ground lug.
 - c. Remove all front panel RF connectors and the ground lug from the front panel.
5. To remove front panel fuse holders and BIAS connectors:
 - a. Cut the shrink tubing off of the fuse holders and BIAS connectors.
 - b. Unsolder all wires from the fuse holders and BIAS connectors.
 - c. Remove all hardware (hex nuts and washers) from the fuse holders and BIAS connectors.
 - d. Remove the fuse holders and BIAS connectors from the front panel.
6. To remove the front panel LED cable:
 - a. Remove all hardware (hex nuts and washers) from the LED mounting studs.
 - b. Remove the LED cable from the front panel.
7. To remove the front panel LINE switch:
 - a. Disconnect all wires from the rear of the front panel LINE switch.
 - b. Depress the retainer clips on the sides of the LINE switch and push the LINE switch out the front of the front panel.

Figure 7-1 Front Panel Parts Removal (1)

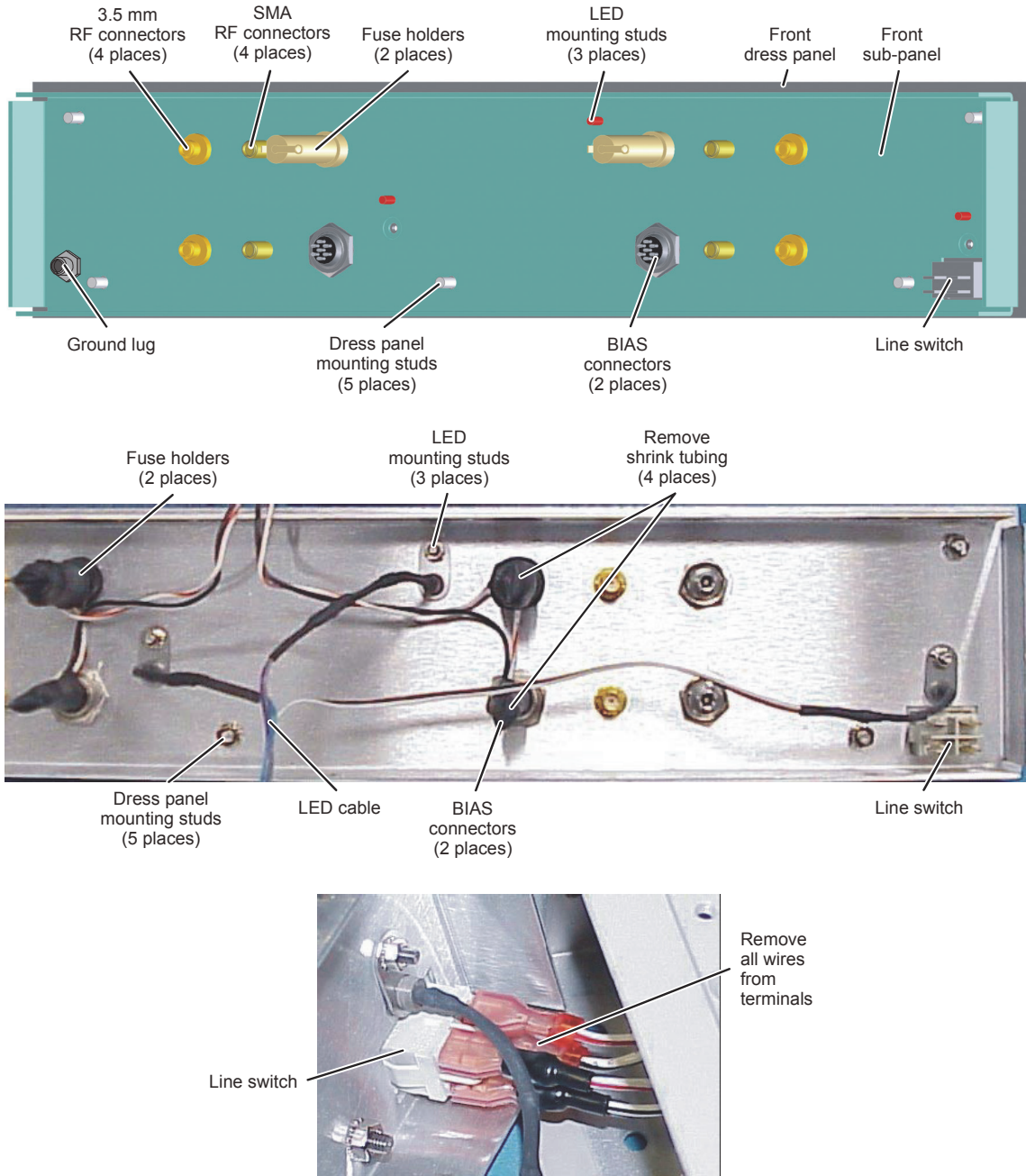

n5260_001_618

8. To remove the front dress panel:
 - a. Remove the hex nuts from the five mounting studs (item ①) that hold the front dress panel in place.
 - b. Remove the dress panel from the front.
9. Remove the front sub-panel:
 - a. Remove the eight screws (item ①) that attach the front sub-panel to the front frame.
 - b. Remove the sub-panel from the front of the front frame.

Replacement Procedure

1. Reverse the order of the removal procedure.
1. Be sure to re-solder the wires on the BIAS fuse holders and connectors and to cover them with shrink tubing as they were originally.

Figure 7-2 Front Panel Parts Removal (2)

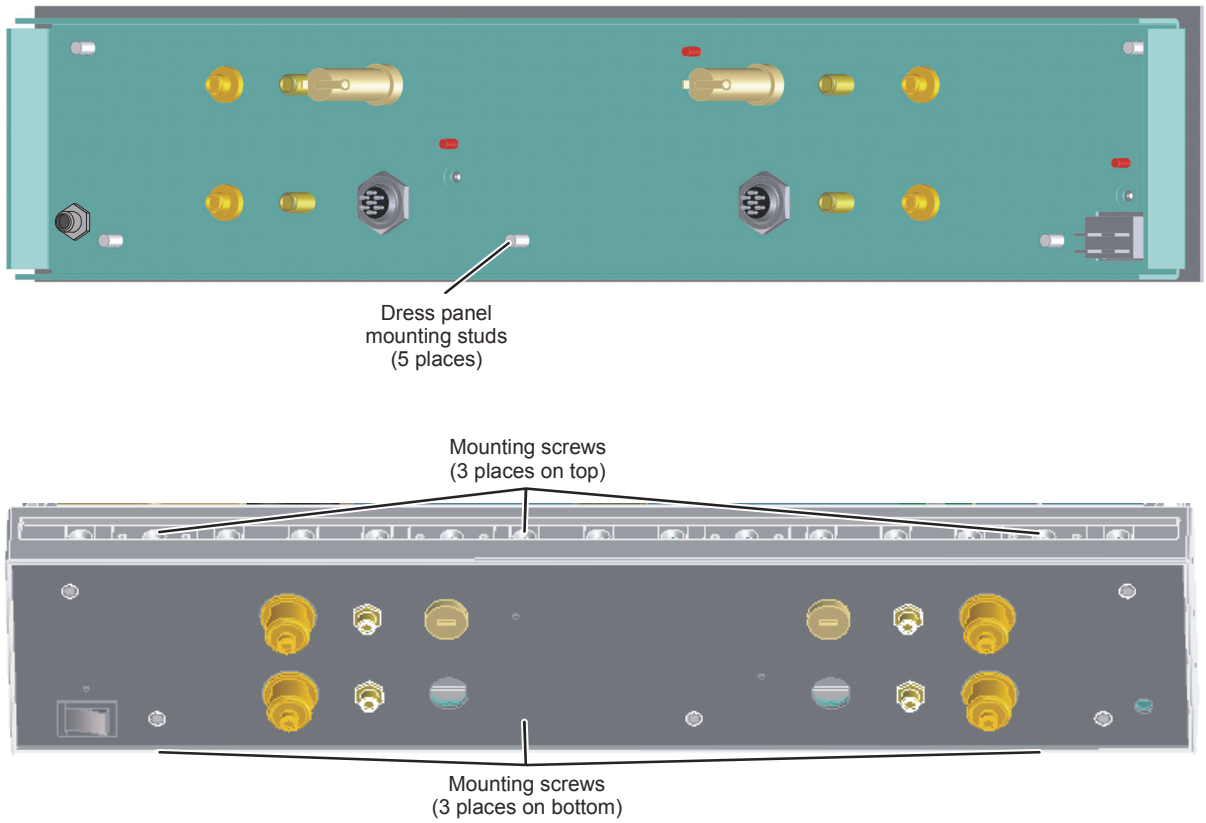

n5260_001_619

Removing and Replacing the A1 and A21 Power Supply Boards

Tools Required

- T-10 TORX driver (set to 9 in-lb)
- ESD grounding wrist strap

Removal Procedure

Refer to [Figure 7-3](#) for this procedure.

1. Disconnect the power cord.
2. Remove the top cover. Refer to “[Removing and Replacing External Parts](#)” on page 7-5.
3. Remove the side cover. Refer to “[Removing and Replacing External Parts](#)” on page 7-5.
4. Disconnect two wire harness cables (item ①) from the board to be removed.
5. Remove the protective shield (item ②) from the board to be removed by removing two screws (item ③).
6. Remove two screws (item ④) from the appropriate power supply heat sink.
7. Remove four screws (item ⑤) from the power supply board to be removed. If removing the A1 power supply board, there is a ground lug under one of the screws, (item ⑥).

Replacement Procedure

1. Reverse the order of the removal procedure being sure to replace the ground lug under screw (item ⑥), if replacing the A1 power supply board.

Figure 7-3 A1 and A21 Power Supply Boards Removal

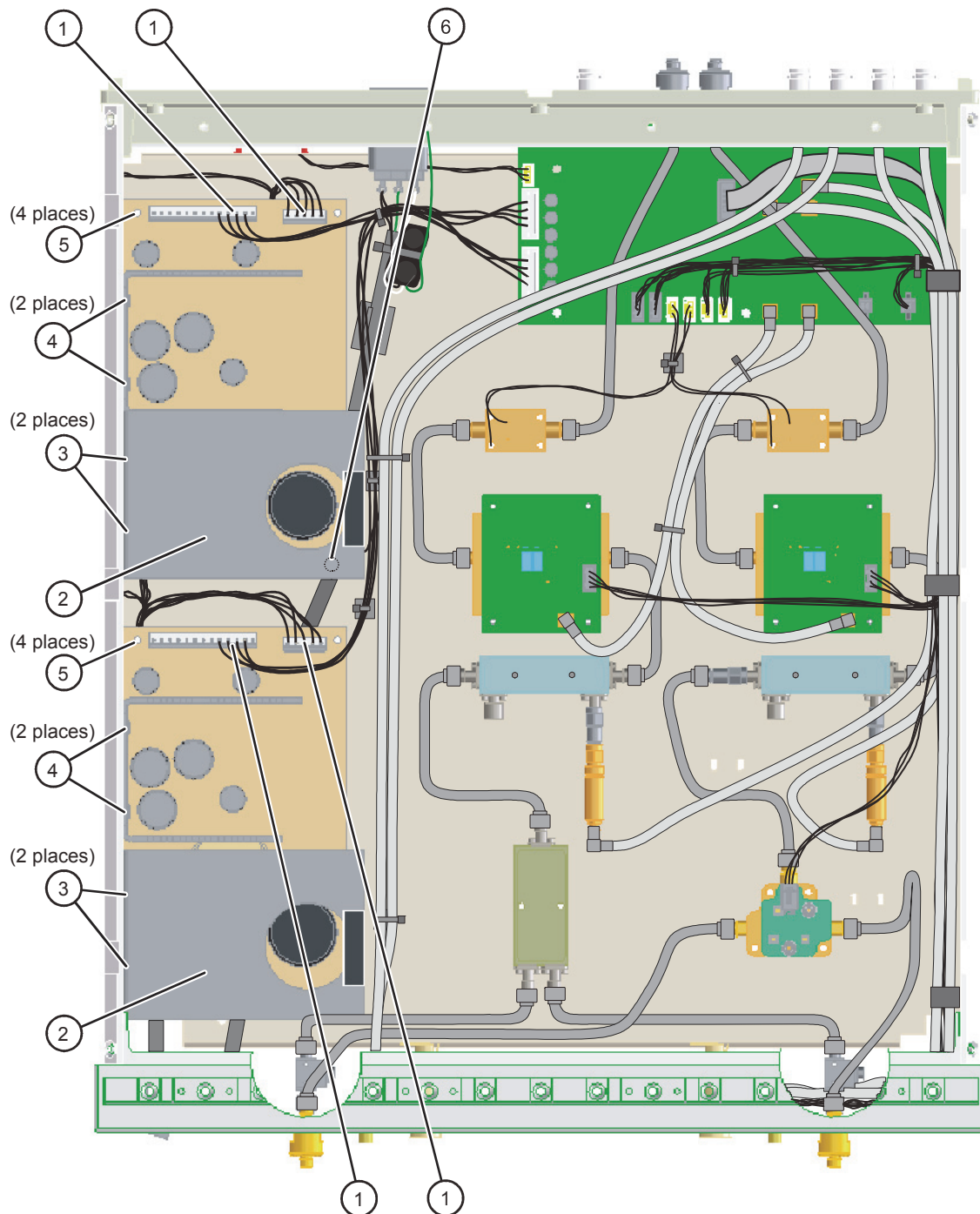

n5260_001_607

Removing and Replacing the A3 and A8 Buffer Amplifiers

Tools Required

- T-10 TORX driver (set to 9 in-lb)
- 5/16 inch open-end torque wrench (set to 10 in-lb)
- Soldering iron and solder
- ESD grounding wrist strap

Removal Procedure

Refer to [Figure 7-4](#) for this procedure.

CAUTION Be careful not to damage the center pins of the semirigid cables. Some flexing of the cables may be necessary. However, do not over-bend the semirigid cables.

1. Disconnect the power cord.
2. Remove the top cover. Refer to [“Removing and Replacing External Parts” on page 7-5](#).
3. Disconnect two semi-rigid cables (item ①) from the amplifier to be removed.
4. Unsolder the wire from the terminal (item ②) on the amplifier to be removed.
5. Remove four screws (item ③) from the amplifier to be removed. There is a ground lug under one of the screws, (item ④).

Replacement Procedure

1. Reverse the order of the removal procedure being sure to replace the ground lug under screw (item ④), and to re-solder the wire onto the amplifier terminal.

Figure 7-4 A3 and A8 Buffer Amplifiers Removal

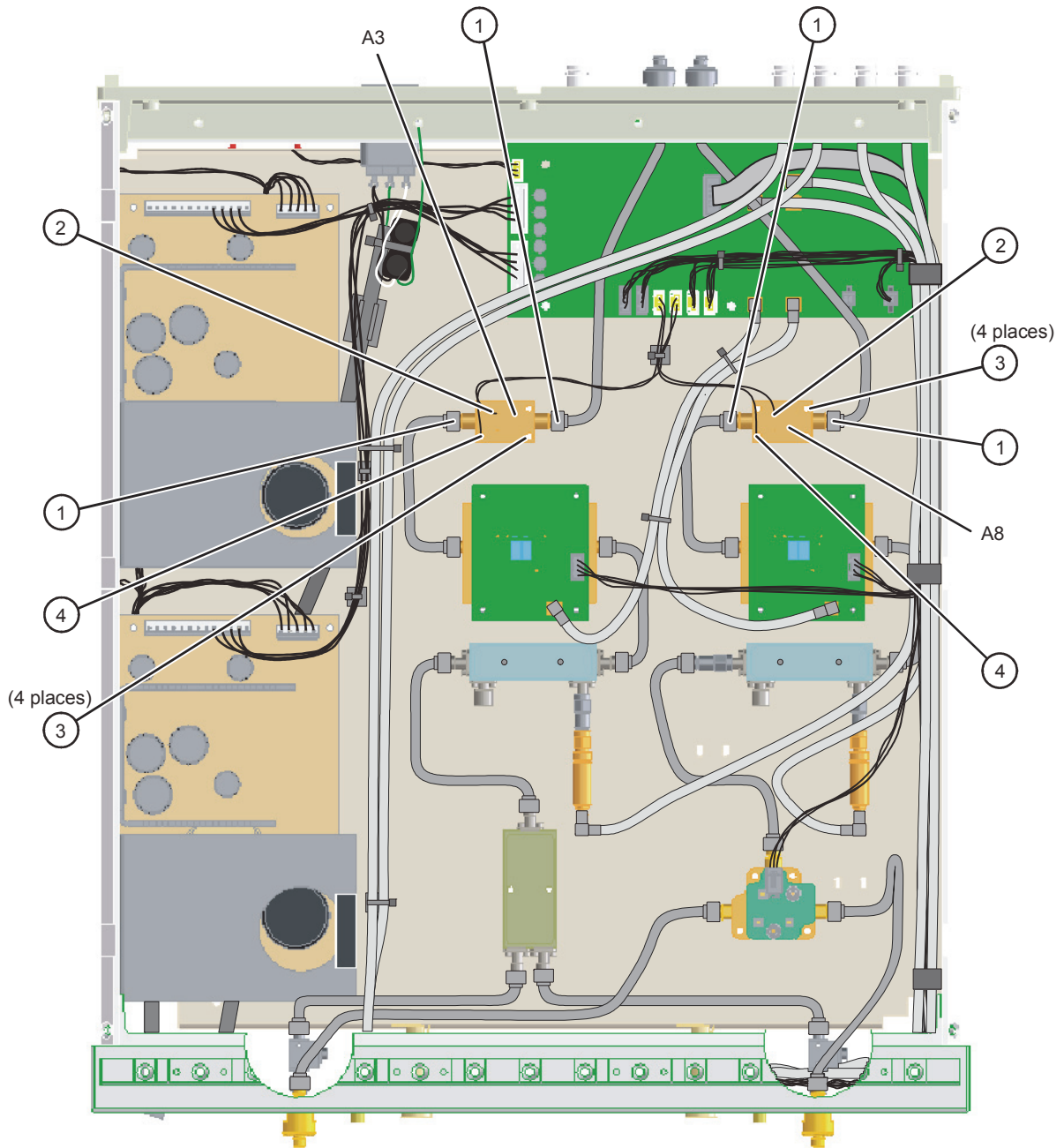

n5260_001_608

Removing and Replacing the A4 and A7 Modulator/Amplifiers and the A5 and A6 Bias Boards

Tools Required

- T-10 TORX driver (set to 9 in-lb)
- 5/16 inch open-end torque wrench (set to 10 in-lb)
- ESD grounding wrist strap

Removal Procedure

Refer to [Figure 7-5](#) for this procedure.

CAUTION Be careful not to damage the center pins of the semirigid cables. Some flexing of the cables may be necessary. However, do not over-bend the semirigid cables.

1. Disconnect the power cord.
2. Remove the top cover. Refer to “[Removing and Replacing External Parts](#)” on page 7-5.
3. The A5 or A6 bias board must be removed before the A4 or A7 modulator/amplifier can be removed.
4. Removing the A5 or A6 bias board:
 - a. Disconnect the flexible RF cable (item ①) from the bias board to be removed.
 - b. Disconnect the wire harness (item ②) from the bias board to be removed.
 - c. Remove four screws (item ③) from the bias board to be removed.
 - d. Lift the bias board off of the modulator/amplifier being careful not to damage the interconnecting pins.
5. Removing the A4 or A7 modulator/amplifier:
 - a. Disconnect two semi-rigid cables (item ④) from the modulator/amplifier to be removed.
 - b. Remove four screws (item ⑤) from the modulator/amplifier to be removed. These screws were obscured from view by the bias board.

Replacement Procedure

1. Reverse the order of the removal procedure.

Figure 7-5 A4 through A7 Removal

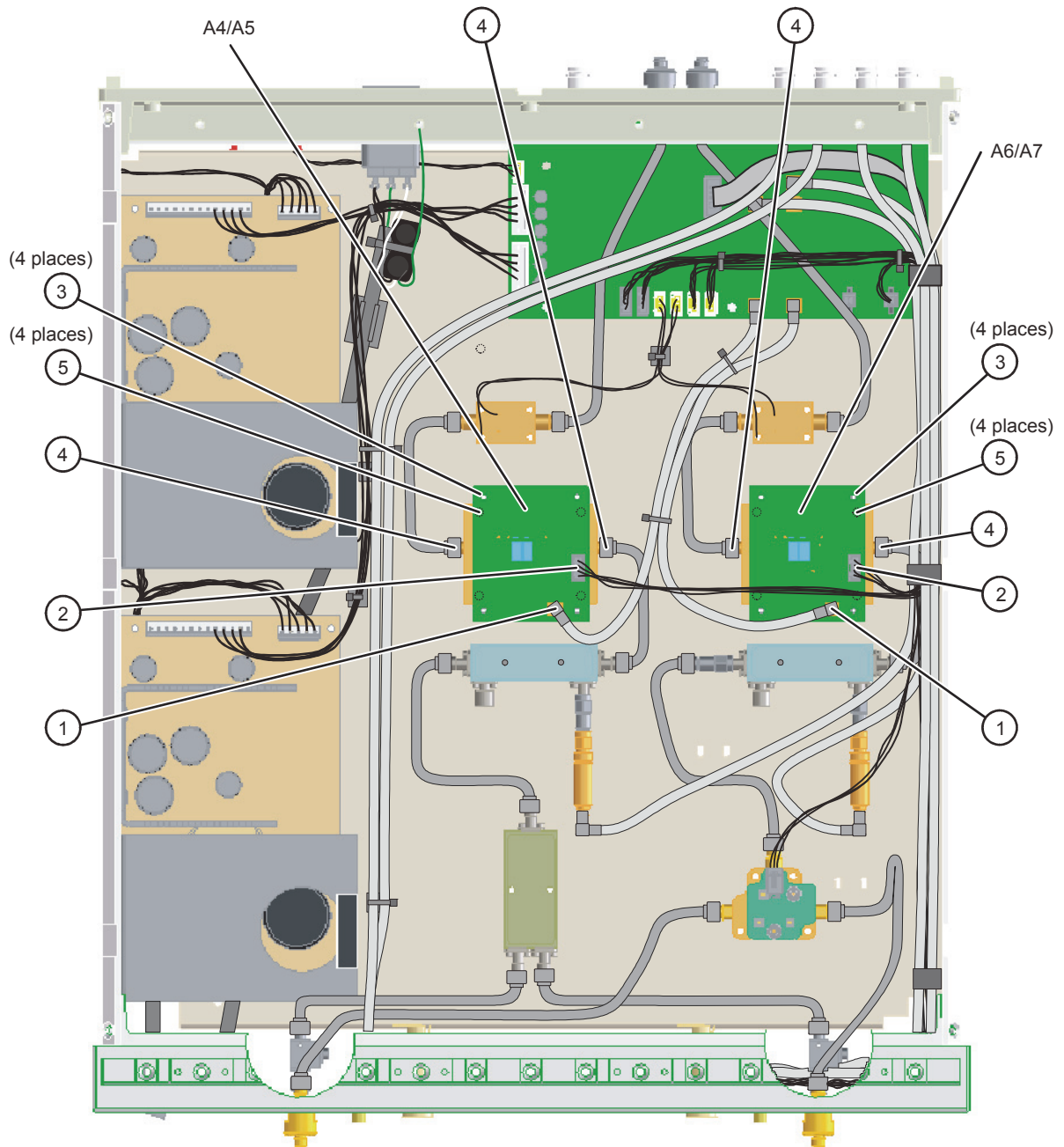

n5260_001_609

Removing and Replacing the A9 Test Set Interface Control Board

Tools Required

- T-10 TORX driver (set to 9 in-lb)
- 5/16 inch open-end torque wrench (set to 10 in-lb)
- ESD grounding wrist strap

Removal Procedure

Refer to [Figure 7-6](#) for this procedure.

CAUTION Be careful not to damage the center pins of the semirigid cables. Some flexing of the cables may be necessary. However, do not over-bend the semirigid cables.

1. Disconnect the power cord.
2. Remove the top cover. Refer to [“Removing and Replacing External Parts”](#) on page 7-5.
3. Remove the two semi-rigid cables (item ①) from between the A3 and A8 buffer amplifiers and the rear-panel LO and RF DRIVES connectors.
4. Remove the four flexible RF cables (item ②) from the A9 test set interface control board.
5. Remove the ten wire harness cables (item ③) from the A9 test set interface control board.
6. Remove the ribbon cable (item ④) from the A9 test set interface control board.
7. Remove the two jack screws and lock washers (item ⑤) from the rear-panel Test Set Interface I/O connector.
8. Remove four screws (item ⑥) from the A9 test set interface control board and lift the board out of the instrument.

Replacement Procedure

1. [Figure 7-15 on page 7-33](#) shows the location of the S1 dip switch. Verify the eight switches on this dip switch are in the following positions:
 - Switch 1 = on
 - Switches 2 through 8 = off
2. Reverse the order of the removal procedure.

Figure 7-6 A9 Test Set Interface Control Board Removal

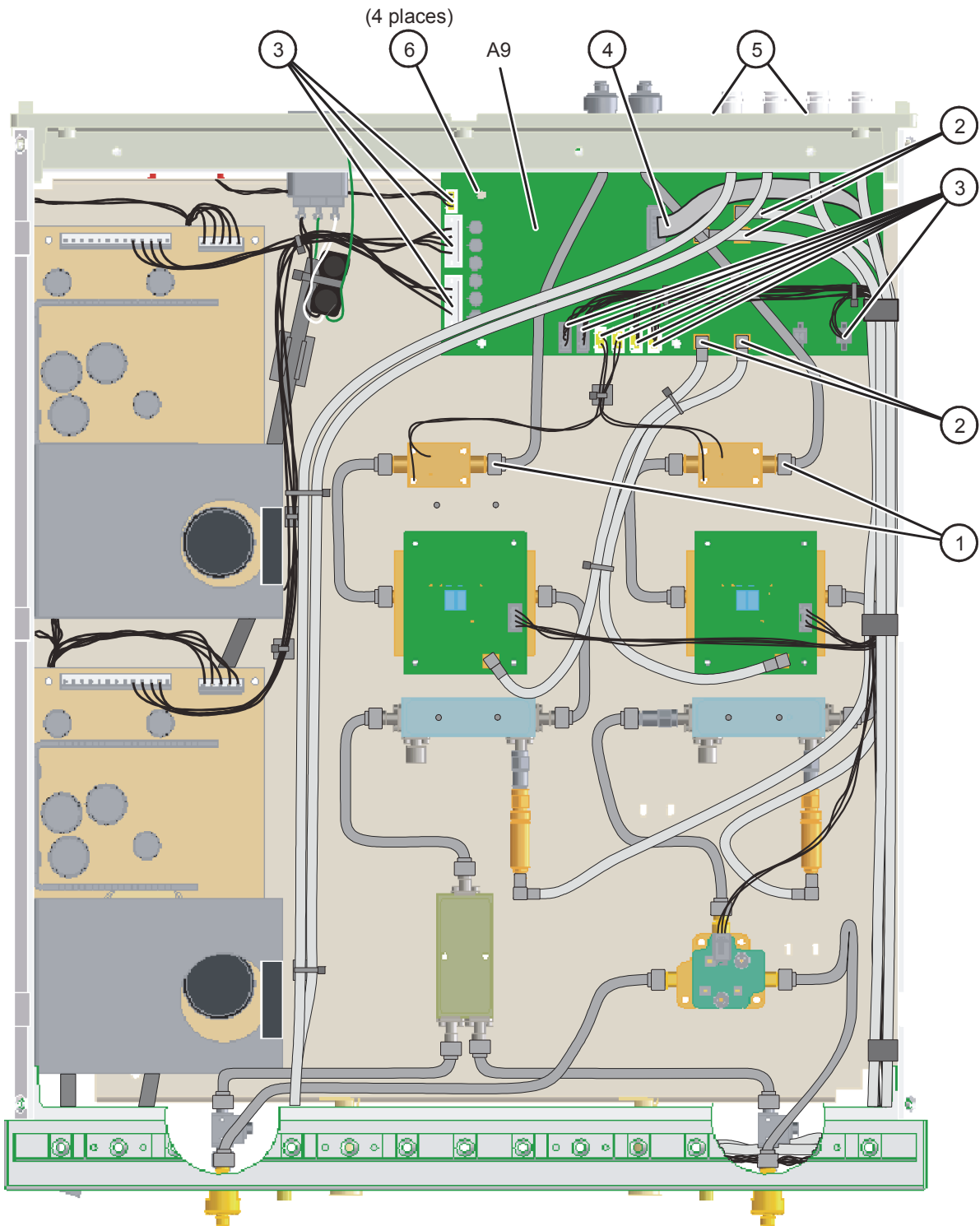

n5260_001_615

Removing and Replacing the A10 and A16 Couplers

Tools Required

- T-10 TORX driver (set to 9 in-lb)
- 5/16 inch open-end torque wrench (set to 10 in-lb)
- ESD grounding wrist strap

Removal Procedure

Refer to [Figure 7-7](#) for this procedure.

CAUTION Be careful not to damage the center pins of the semirigid cables. Some flexing of the cables may be necessary. However, do not over-bend the semirigid cables.

1. Disconnect the power cord.
2. Remove the top cover. Refer to “[Removing and Replacing External Parts](#)” on page 7-5.
3. Disconnect the flexible RF cable (item ①) from the coupler to be removed.
4. Disconnect two semi-rigid cables (item ②) from the coupler to be removed.
5. Remove two screws (item ③) from the coupler to be removed.
6. Remove the coupler with the other assemblies (A11, A12, A13, A17, A18) still attached.

Replacement Procedure

1. If replacing the A10 coupler:
 - a. Remove the A17 attenuator and the A18 detector from the old coupler and attach them to the new coupler.
 - b. Install the new coupler by reversing the removal procedure.
1. If replacing the A16 coupler:
 - a. Remove the A11 attenuator from the old coupler and attach it to the new coupler.
 - b. Remove the A12 attenuator and the A13 detector from the old coupler and attach them to the new coupler.
 - c. Install the new coupler by reversing the removal procedure.

Figure 7-7 A10 and A16 Couplers Removal

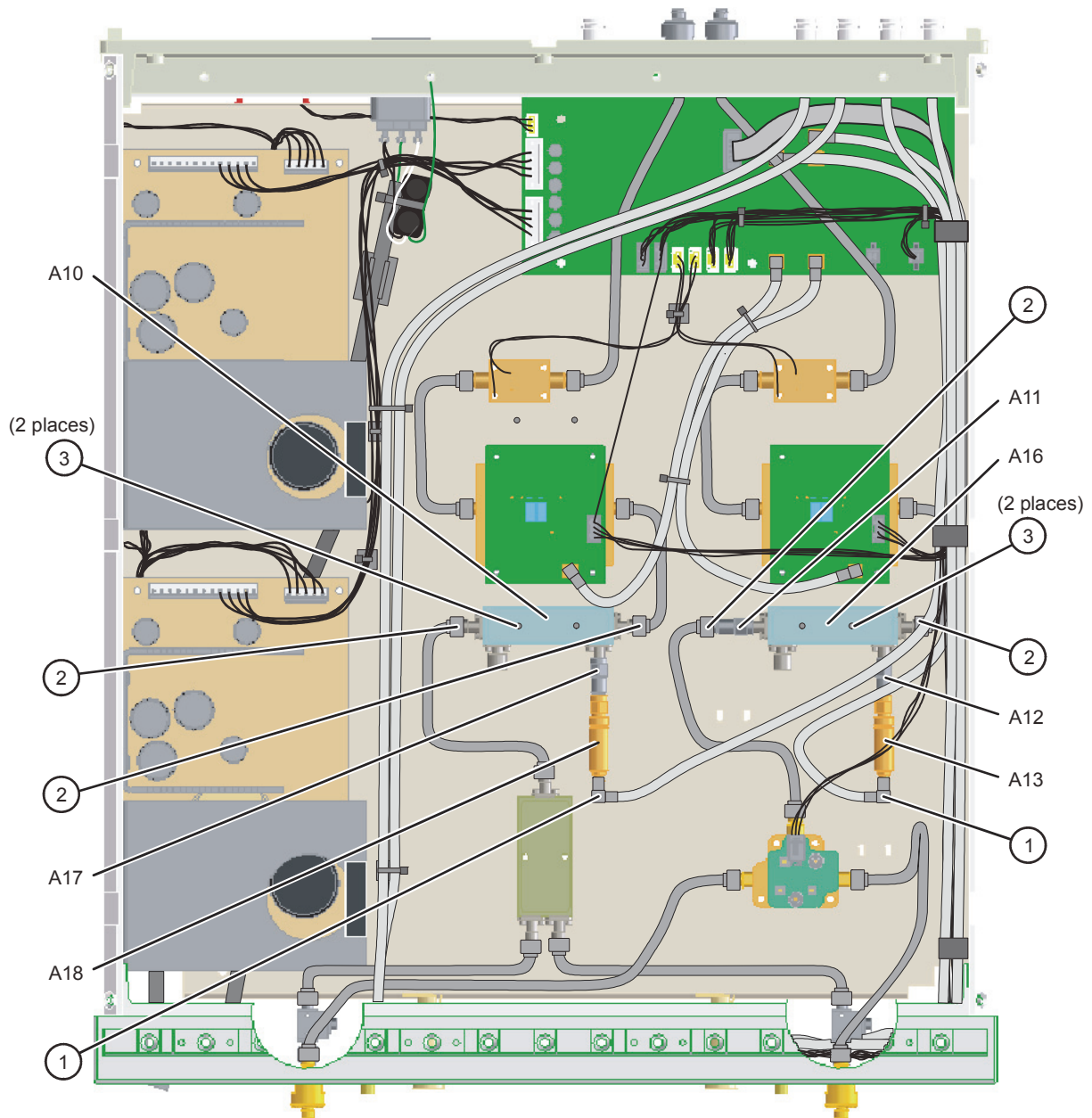

n5260_001_610

Removing and Replacing the A11, A12 and A17 Attenuators and the A13 and A18 Detectors

Tools Required

- 5/16 inch open-end torque wrench (set to 10 in-lb)
- ESD grounding wrist strap

Removal Procedure

Refer to [Figure 7-8](#) for this procedure.

CAUTION Be careful not to damage the center pins of the semirigid cables. Some flexing of the cables may be necessary. However, do not over-bend the semirigid cables.

1. Disconnect the power cord.
2. Remove the top cover. Refer to [“Removing and Replacing External Parts”](#) on page 7-5.
3. If removing the A11 attenuator:
 - a. Remove the semi-rigid cable (item ①) from the A11 attenuator.
 - b. Remove the A11 attenuator.
4. If removing the A13 or A18 detector:
 - a. Remove the flexible RF cable (item ②) from the detector to be removed.
 - b. Remove the detector.
5. If removing the A12 or A17 attenuator:
 - a. Remove the flexible RF cable (item ②) from the detector (A13 or A18) attached to the attenuator (A12 or A17) to be removed.
 - b. Remove the detector (A13 or A18) attached to the attenuator (A12 or A17) to be removed.
 - c. Remove the desired attenuator (A12 or A17).

Replacement Procedure

1. Reverse the order of the removal procedure being careful to install all good components that were previously removed, in the same locations as they were originally installed.

Figure 7-8 A11, A12, A13, A17, and A18 Removal

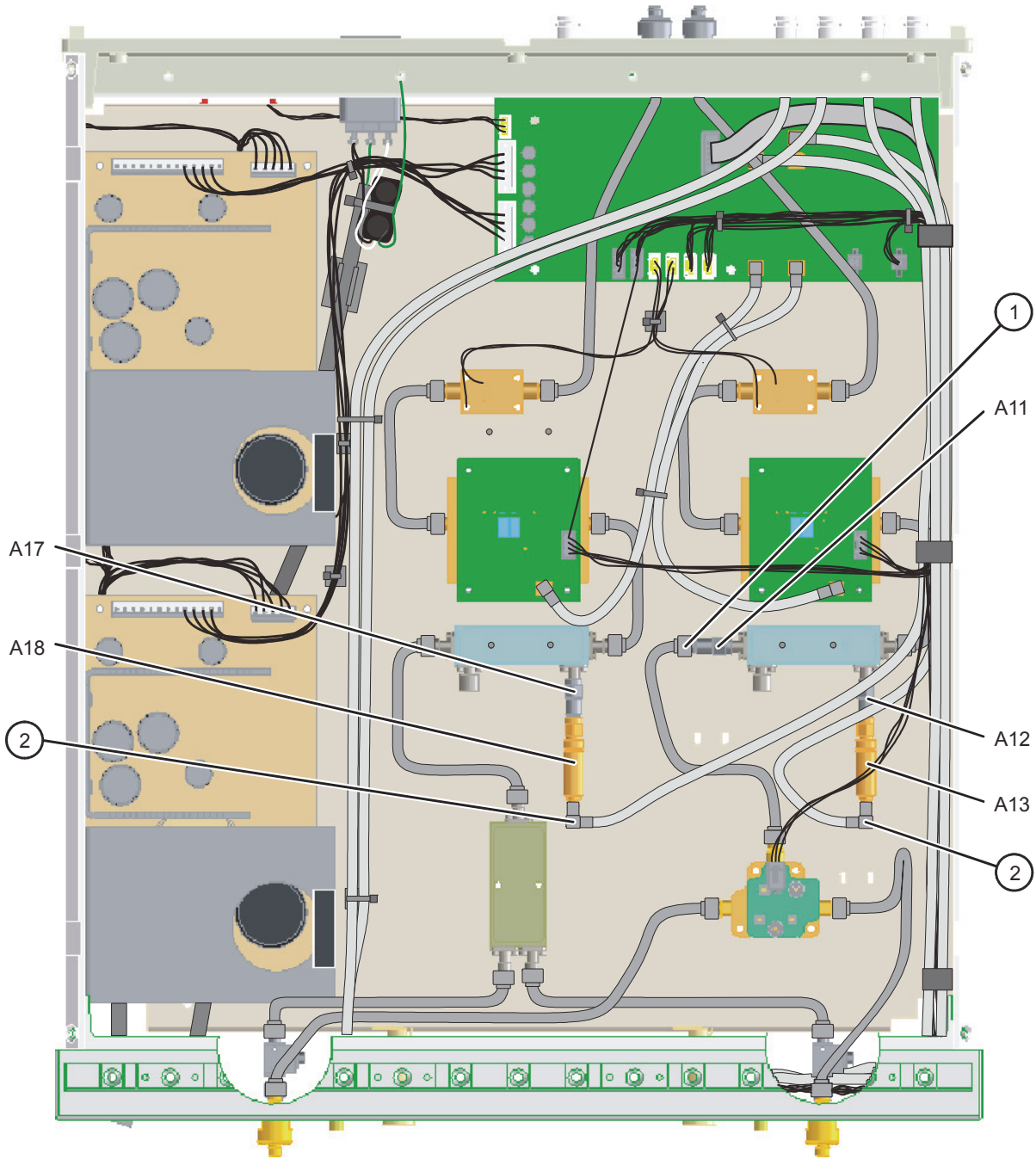

n5260_001_611

Removing and Replacing the A14 RF Switch

Tools Required

- T-10 TORX driver (set to 9 in-lb)
- 5/16 inch open-end torque wrench (set to 10 in-lb)
- ESD grounding wrist strap

Removal Procedure

Refer to [Figure 7-9](#) for this procedure.

CAUTION Be careful not to damage the center pins of the semirigid cables. Some flexing of the cables may be necessary. However, do not over-bend the semirigid cables.

1. Disconnect the power cord.
2. Remove the top cover. Refer to [“Removing and Replacing External Parts”](#) on page 7-5.
3. Disconnect the wire harness cable (item ①) from the A14 RF switch.
4. Remove the three semi-rigid cables (item ②) from the A14 RF switch.
5. Remove four screws (item ③) from the A14 RF switch.

Replacement Procedure

1. Reverse the order of the removal procedure.

Figure 7-9 A14 RF Switch Removal

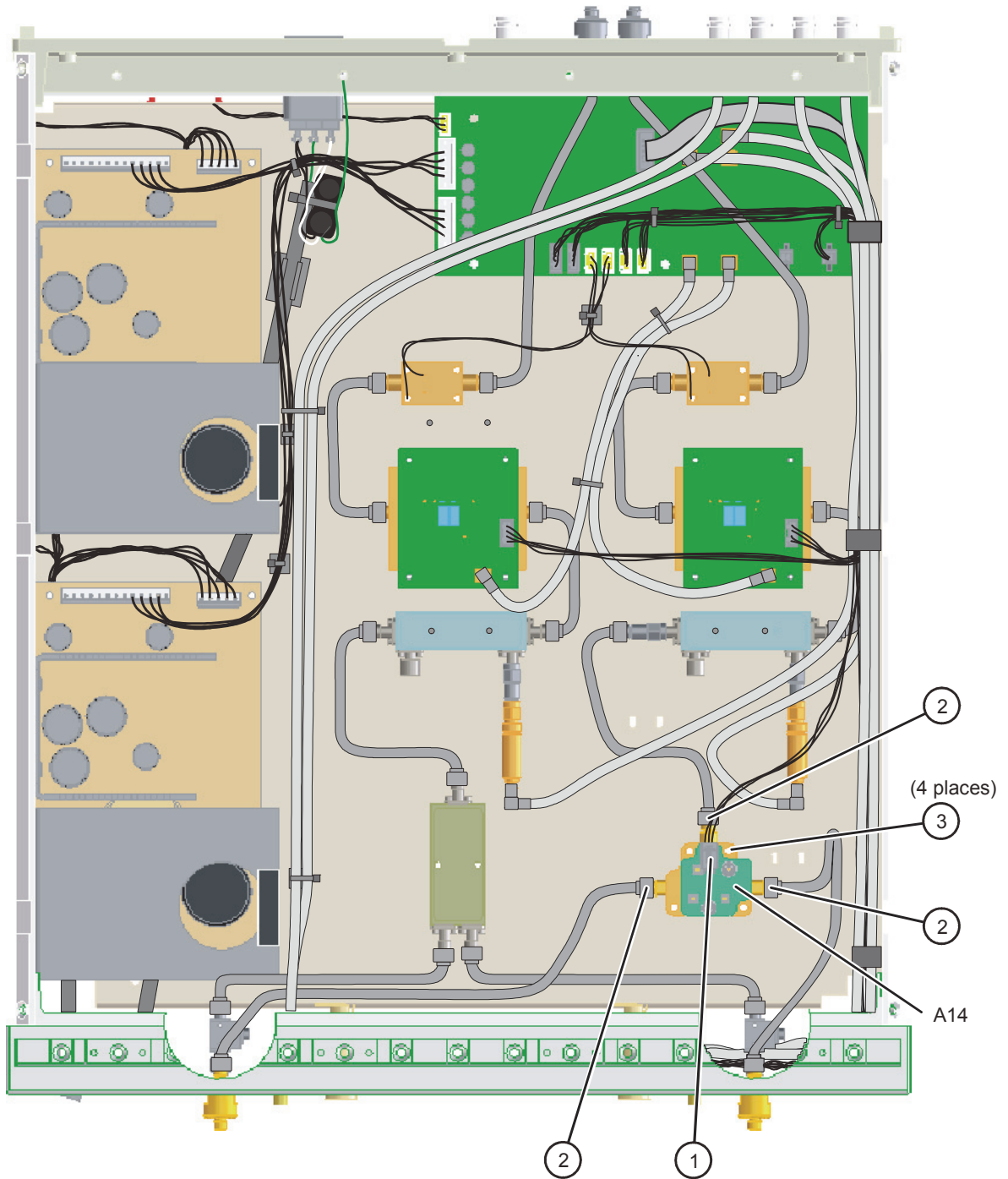

n5260_001_612

Removing and Replacing the A19 Power Divider

Tools Required

- T-10 TORX driver (set to 9 in-lb)
- 5/16 inch open-end torque wrench (set to 10 in-lb)
- ESD grounding wrist strap

Removal Procedure

Refer to [Figure 7-10](#) for this procedure.

CAUTION Be careful not to damage the center pins of the semirigid cables. Some flexing of the cables may be necessary. However, do not over-bend the semirigid cables.

1. Disconnect the power cord.
2. Remove the top cover. Refer to “[Removing and Replacing External Parts](#)” on page 7-5.
3. Remove the three semi-rigid cables (item ①) from the A19 power divider.
4. Remove two screws (item ②) from the A19 power divider.

Replacement Procedure

1. Reverse the order of the removal procedure.

Figure 7-10 A19 Power Divider Removal

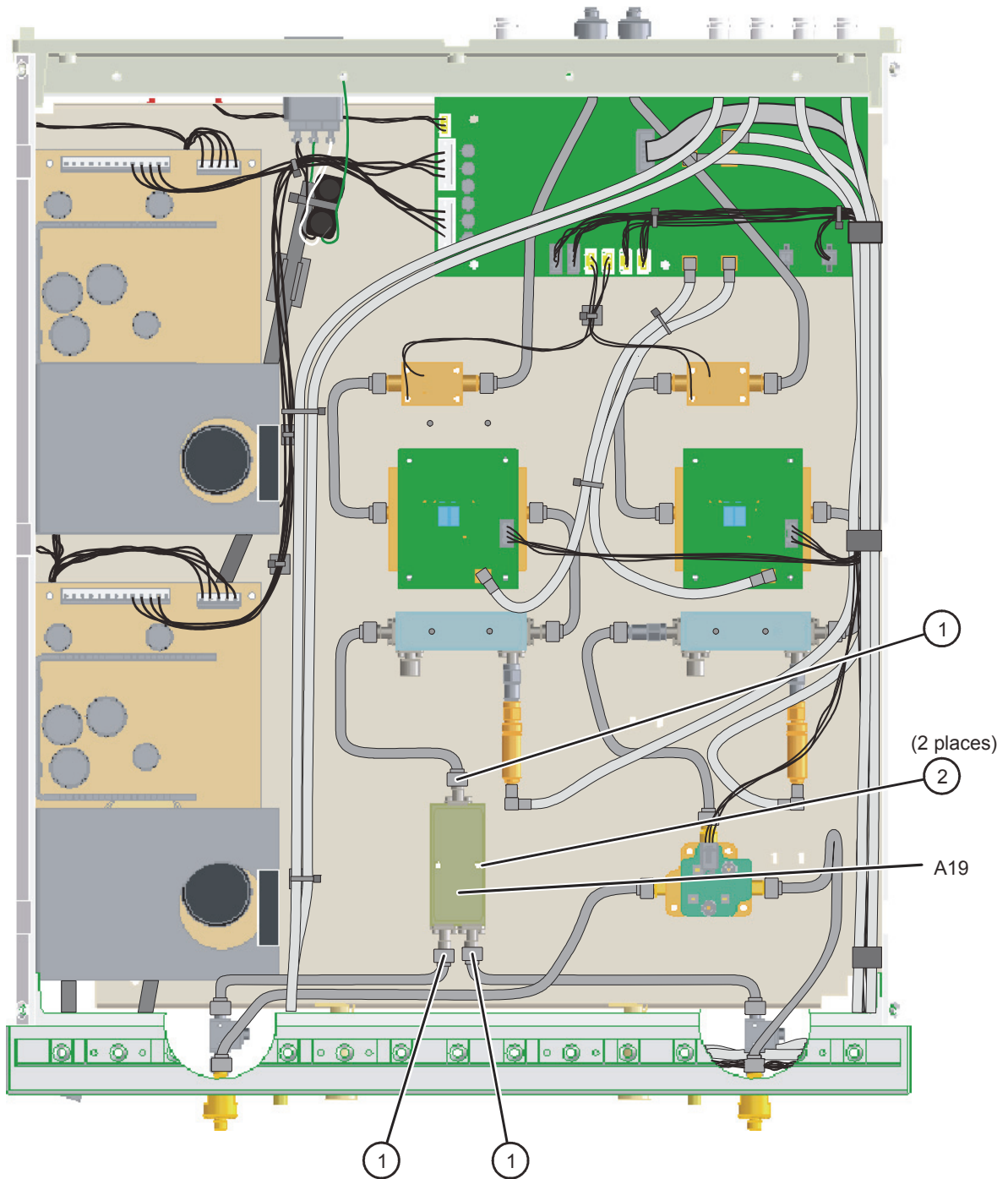

n5260_001_613

Removing and Replacing the A15 and A20 Isolators

Tools Required

- 5/16 inch open-end torque wrench (set to 10 in-lb)
- ESD grounding wrist strap

Removal Procedure

Refer to [Figure 7-11](#) for this procedure.

CAUTION Be careful not to damage the center pins of the semirigid cables. Some flexing of the cables may be necessary. However, do not over-bend the semirigid cables.

1. Disconnect the power cord.
2. Remove the top cover. Refer to “[Removing and Replacing External Parts](#)” on page 7-5.
3. Remove the semi-rigid cable (item ①) from the isolator to be removed.
4. Remove the isolator (A15 or A19) from the front panel connector.

Replacement Procedure

1. Reverse the order of the removal procedure.

Figure 7-11 A15 and A20 Isolators Removal

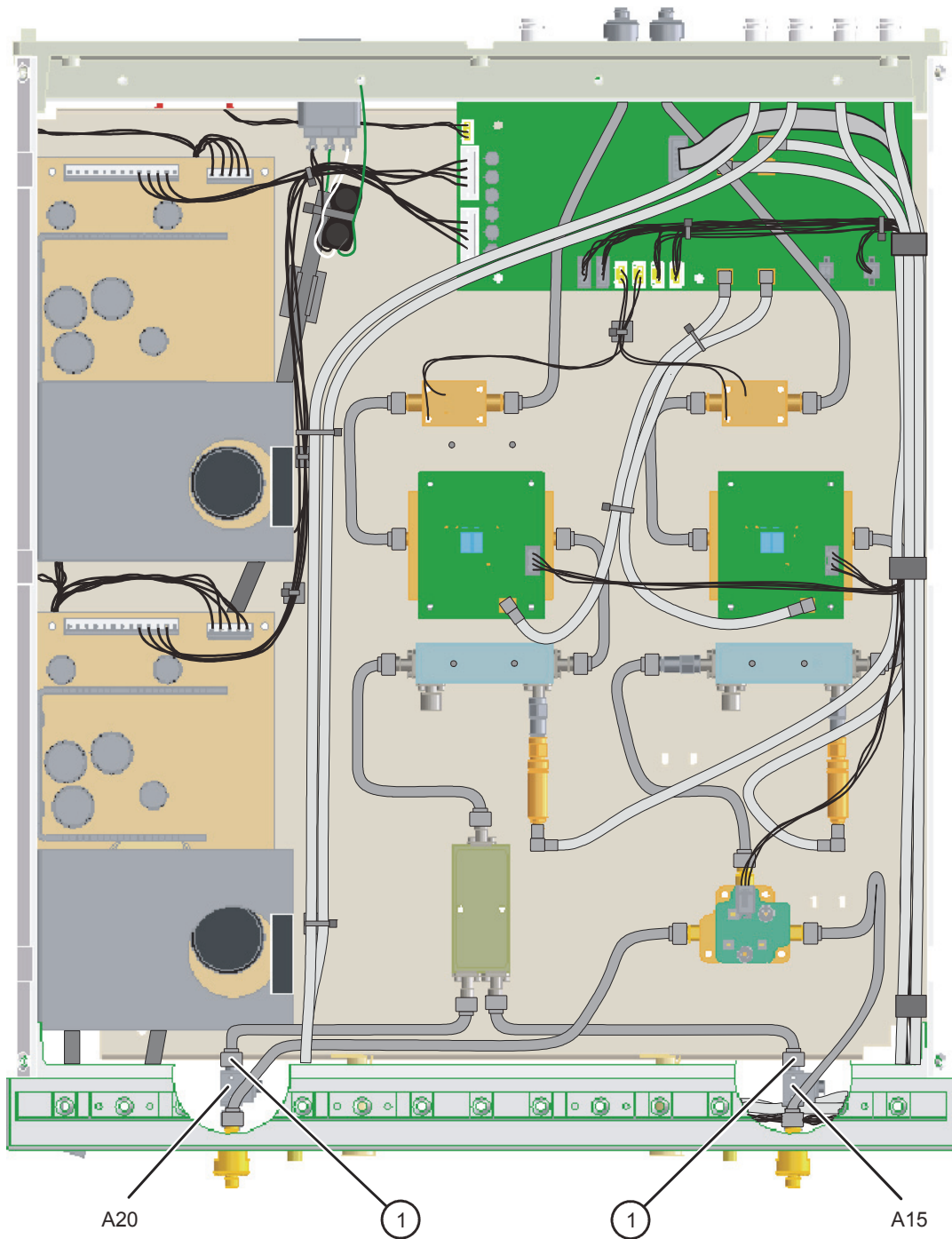

n5260_001_614

Removing and Replacing the Fan

Tools Required

- T-10 TORX driver (set to 9 in-lb)
- ESD grounding wrist strap

Removal Procedure

Refer to [Figure 7-12](#) for this procedure.

1. Disconnect the power cord.
2. Remove the top cover. Refer to “[Removing and Replacing External Parts](#)” on page 7-5.
3. Disconnect the fan cable from the A9 test set interface control board.
4. Remove four hex nuts (item ①) from the fan and remove the fan from the instrument.

Replacement Procedure

1. Reverse the order of the removal procedure.

Figure 7-12 Fan Removal

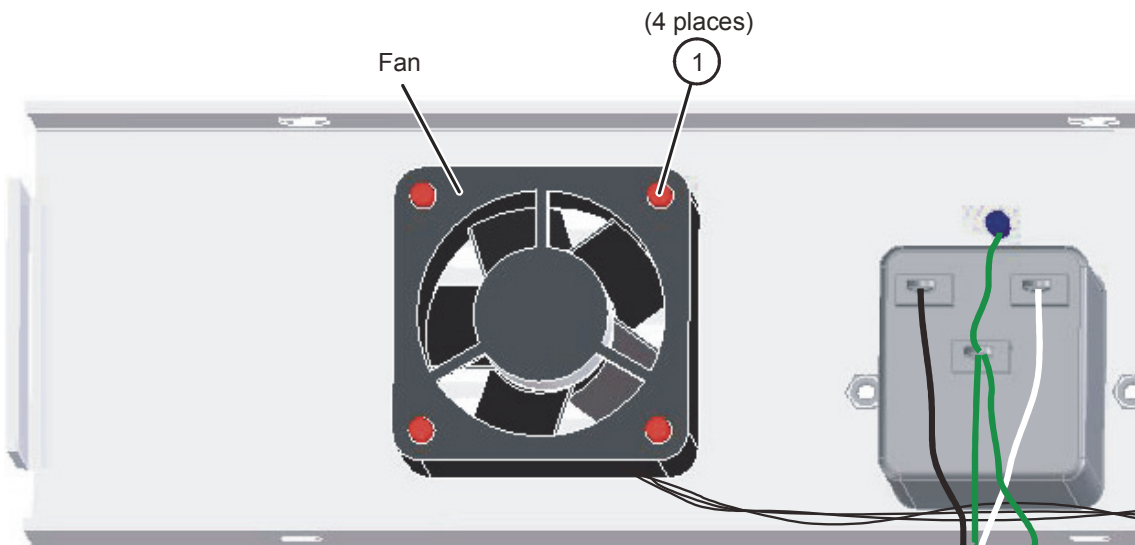
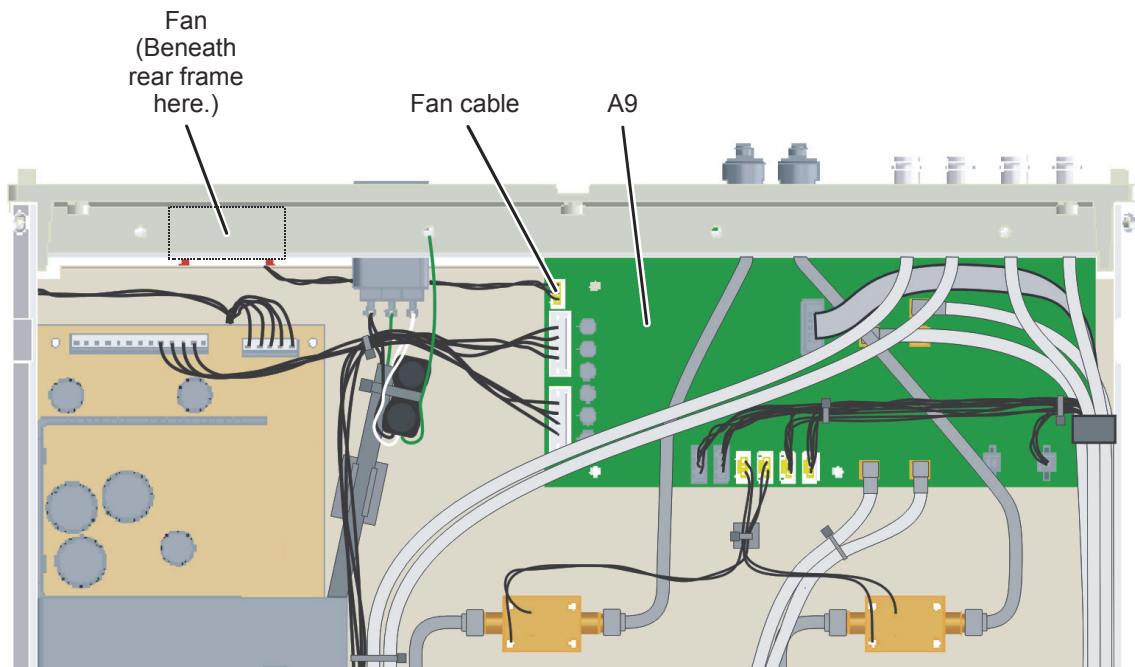

n5260_001_616

Removing and Replacing the A2 AC Line Module and Line Fuse

Tools Required

- T-10 TORX driver (set to 9 in-lb)
- Soldering iron and solder
- ESD grounding wrist strap

Removal Procedure

Refer to [Figure 7-14](#) for this procedure.

1. Disconnect the power cord.
2. Remove the top cover. Refer to [“Removing and Replacing External Parts”](#) on page 7-5.
3. Unsolder all wires from the AC line module.
4. Remove the hex nut (item ①) and remove the ground lug.
5. Remove two screws (item ②) that attach the line module to the rear panel and pull the line module out the back of the rear panel.

Replacement Procedure

1. Reverse the order of the removal procedure being sure to re-connect all ground (green/yellow) wires as they were originally connected.

AC Line Fuse Replacement Procedure

Refer to the illustration below to remove and replace the AC line fuse.

Figure 7-13 AC Line Fuse Replacement

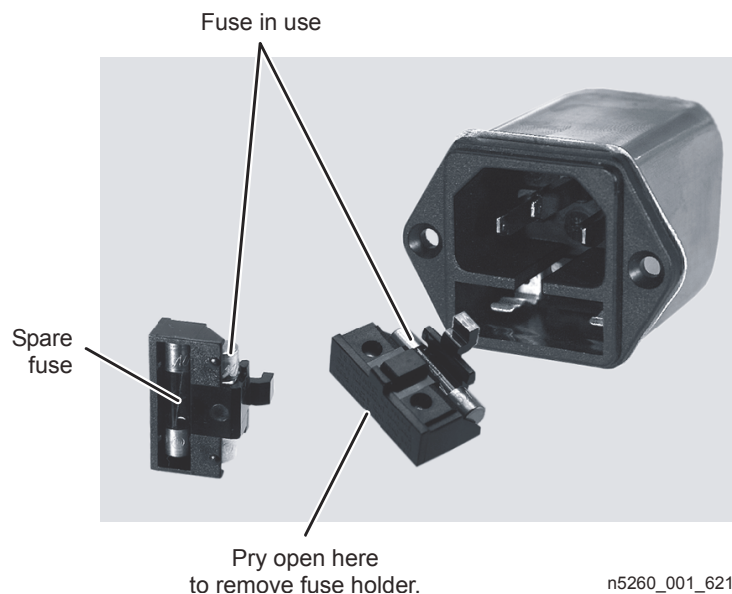
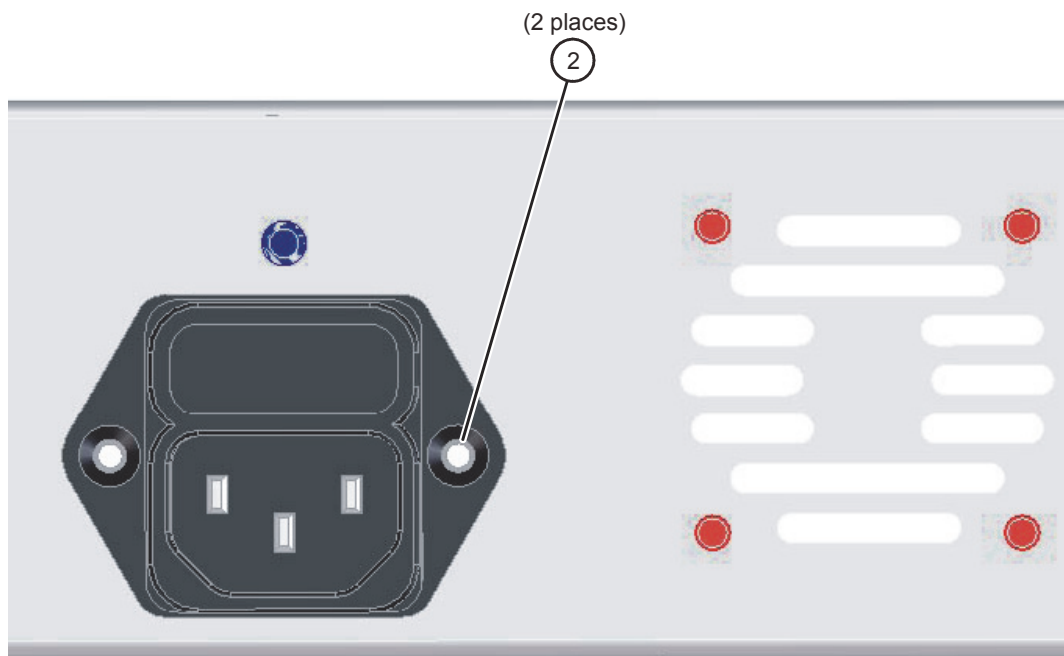
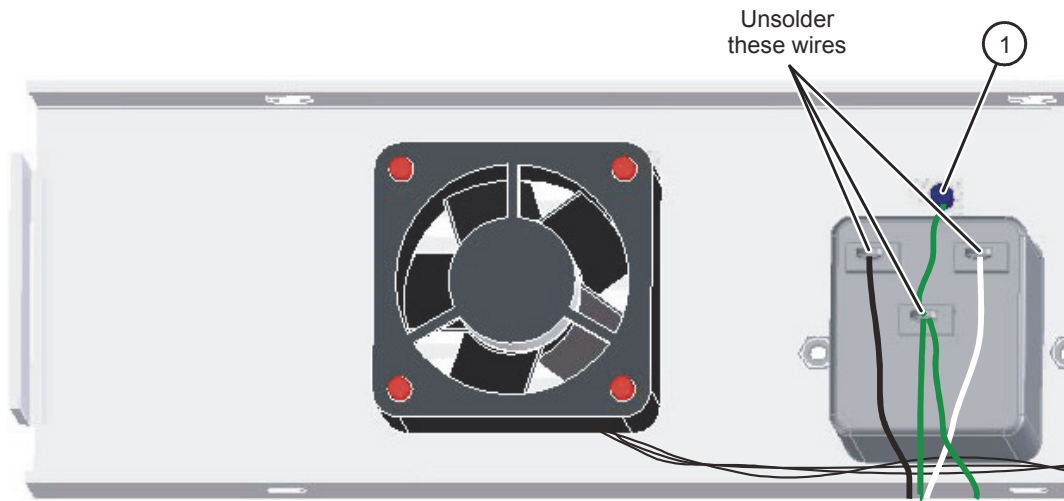

Figure 7-14 AC Line Module Removal



n5260_001_617

Removing and Replacing the Power Supply Fuses

Tools Required

- ESD grounding wrist strap

Removal Procedure

Refer to [Figure 7-15](#) for this procedure.

1. Disconnect the power cord.
2. Remove the top cover. Refer to “[Removing and Replacing External Parts](#)” on page 7-5.
3. Using the illustration in [Figure 7-15](#), locate the faulty fuse. Refer to “[Troubleshooting](#)” on page 5-3 for information on troubleshooting the power supplies and checking the fuses.
4. Remove the faulty fuse and replace it with a new one. Refer to “[Internal Hardware and Miscellaneous Parts](#)” on page 8-12 for part numbers of replacement fuses.
 - Item ①—1A fuses
 - Item ②—5A fuses

Figure 7-15 Power Supply Fuses Removal and Replacement

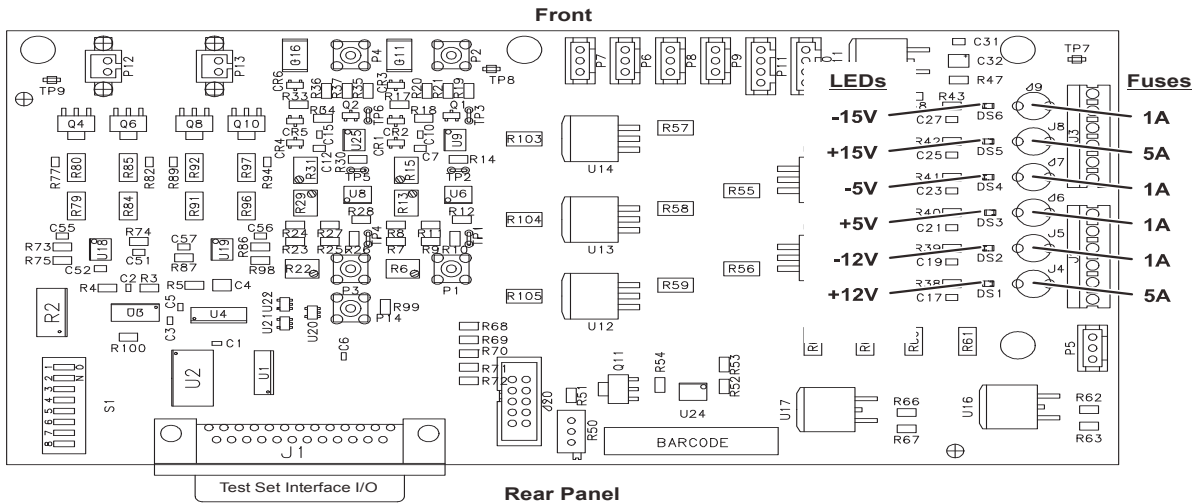
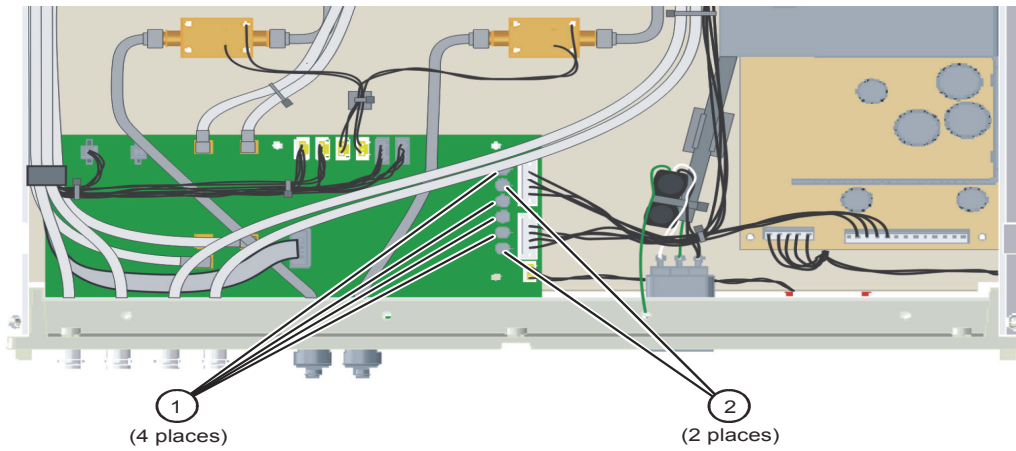

See Figure 8-6 for fuse part numbers.

n5260_001_620

Chapter 8: Replaceable Parts

Information in This Chapter

Chapter Seven at-a-Glance

Section Title	Summary of Content	Start Page
Ordering Information	How to order a replaceable part from Agilent Technologies.	Page 8-2
Replaceable Parts	Tables that list the assemblies by reference designator with their associated part number and description. Illustrations that indicate the location of each of the replaceable parts in your N5260A millimeter head controller.	Page 8-3

Ordering Information

To order a part listed in the replaceable parts lists:

- include the part number
- indicate the quantity required
- Contact Agilent Technologies for instructions on where to send the order. Refer to [“Contacting Agilent” on page 2-7](#).

To order a part that is not listed in the replaceable parts lists:

- include the instrument model number and complete instrument serial number
- include the description and function of the part
- indicate the quantity required
- Contact Agilent Technologies for instructions on where to send the order. Refer to [“Contacting Agilent” on page 2-7](#).

Replaceable Parts

This section contains the replacement part numbers and their descriptions for your N5260A millimeter head controller.

Table 8-1 lists the part number location by type of part.

Table 8-1 Part Number by Type of Part

Type of Part	Location
Assemblies	<ul style="list-style-type: none">• “Internal Assemblies” on page 8-6
Cables	<ul style="list-style-type: none">• “RF Cables” on page 8-8• “Wire Harness and Ribbon Cables” on page 8-10
Hardware	<ul style="list-style-type: none">• “Front Panel” on page 8-4• “Internal Hardware and Miscellaneous Parts” on page 8-12• “Rear Panel” on page 8-14• “Chassis” on page 8-16
Miscellaneous	<ul style="list-style-type: none">• “Miscellaneous” on page 8-18

Front Panel

Reference Designator	Agilent Part Number	Qty	Description
①	5062-6618	4	3.5 mm bulkhead connector, female
	2190-0104	4	Washer, internal lock, 7/16 inch
	2950-0132	4	Nut, hex, 7/16 inch
②	1250-1251	4	SMA bulkhead connector (includes lock washer and hex nut)
③	2110-0565	2	Fuse holder cap, 12A
	2110-1371	2	Fuse, 2A, 250V, very fast acting, 3AB
	2110-0566	2	Fuse holder, 12A, 250V
	1400-0090	2	Washer, lock
	2110-0569	2	Nut, hex
④	Z5623-00058	1	Front dress panel
⑤	Z5623-00059	1	Front sub-panel
⑥	1510-0038	1	Binding post (ground lug)
	2190-0067	1	Washer, internal lock, 1/4 inch
	2950-0006	1	Nut, hex, 1/4 inch
⑦	0535-0082	5	Nut, hex, M4.0, w/ captive lock washer
⑧	85105-80002	2	Connector for bias cable assembly. See “Wire Harness and Ribbon Cables” on page 8-10 for the cable portion of this assembly.
⑨	3101-3008	1	AC line switch, rocker, DPST, 16A, 125VAC

Figure 8-1 Front Panel

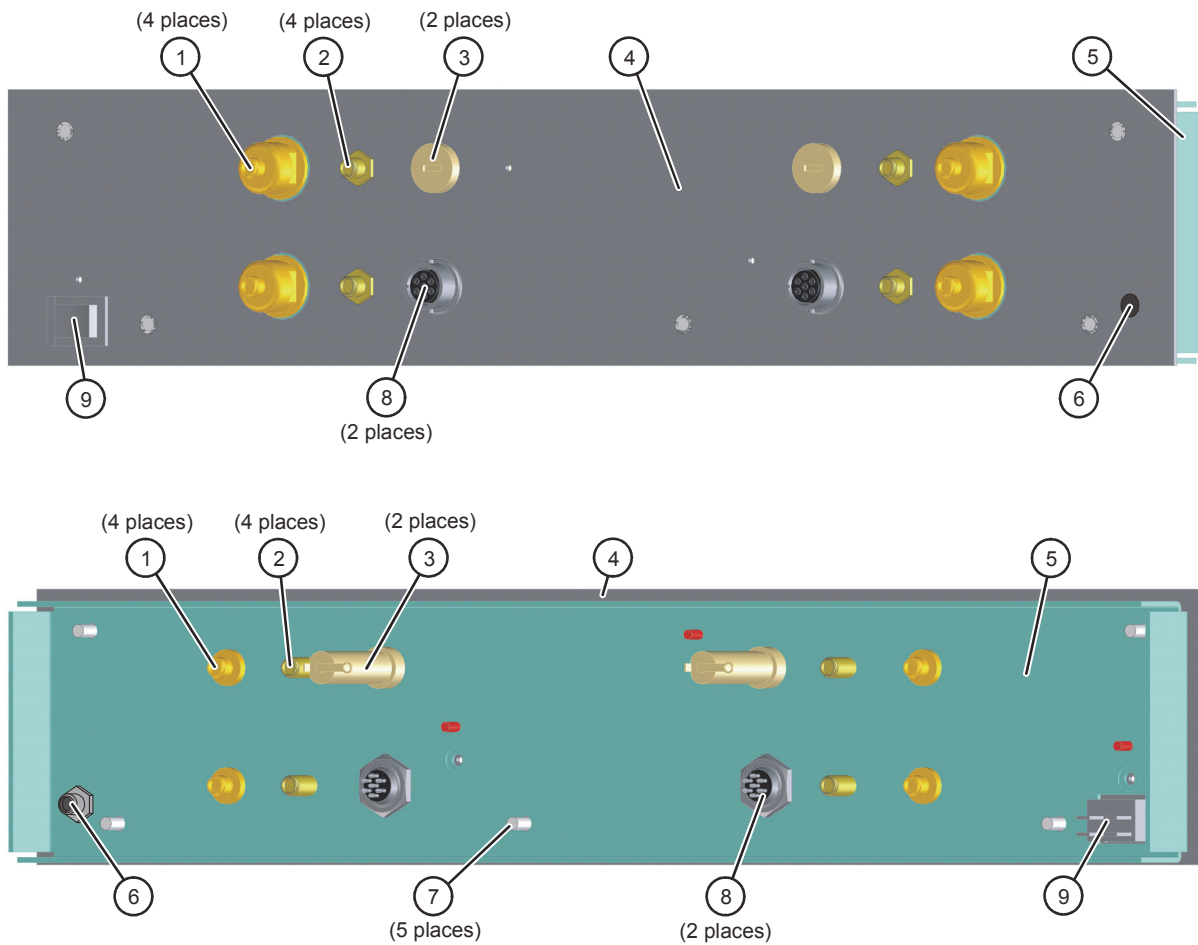

n5260_001_703

Internal Assemblies

Reference Designator	Agilent Part Number	Qty	Description
A1	0950-2252	1	A1 power supply
A2	9135-0270	1	AC line module. P/O AC line cable. See “Wire Harness and Ribbon Cables” on page 8-10.
A3	5087-7290	1	A3 buffer amplifier, LO path
A4	85105-60021	1	A4 modulator/amplifier bias board, LO path
A5	5086-7523	1	A5 modulator/amplifier, LO path
A6	5086-7523	1	A6 modulator/amplifier, RF path
A7	85105-60021	1	A7 modulator/amplifier bias board, RF path
A8	5087-7290	1	A8 buffer amplifier, RF path
A9	Z5623-60271	1	A9 test set interface control board (For a replacement procedure, refer to “Removing and Replacing the A9 Test Set Interface Control Board” on page 7-16.)
	--	--	Fuses. Refer to “Internal Hardware and Miscellaneous Parts” on page 8-12 for part numbers of the power supply fuses on the A9 board.
A10	0955-0125	1	A10 coupler, RF path
A11	0955-0246	1	A11 attenuator, RF path
A12	0955-0243	1	A12 attenuator, RF path
A13	33330-80021	1	A13 detector, RF path
A14	5087-7238	1	A14 RF switch, RF path
A15	0955-1595	1	A15 isolator, port 2
A16	0955-0148	1	A16 coupler, LO path
A17	0955-0243	1	A17 attenuator, LO path
A18	33330-80021	1	A18 detector, LO path
A19	0955-1427	1	A19 power divider (87304C-FG), 2.0-26.5 GHz, LO path
A20	0955-1595	1	A20 isolator, port 1
A21	0950-2596	1	A21 power supply
A22	0955-0243	1	A22 attenuator, RF input

Figure 8-2 Internal Assemblies

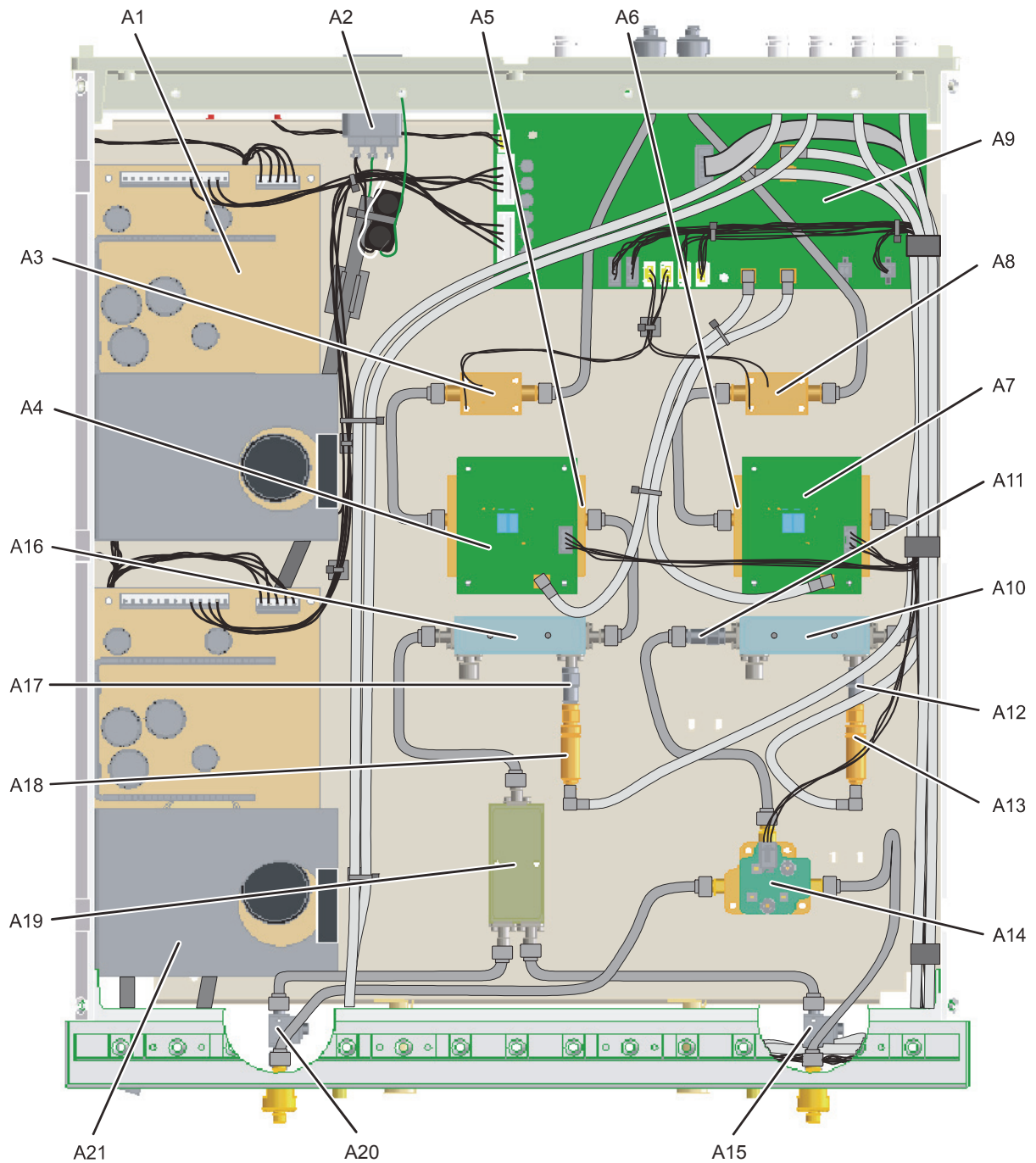

n5260_001_701

RF Cables

Reference Designator	Agilent Part Number	Qty	Description
W1	N5260-20013	1	Rear panel RF IN to A8 RF buffer amplifier
W2	N5260-20009	1	Rear panel LO IN to A3 LO buffer amplifier
W3	N5260-20010	2	A8 RF buffer amplifier to A6 RF modulator/amplifier
W4			A3 LO buffer amplifier to A5 LO modulator/amplifier
W5	N5260-20011	2	A6 RF modulator/amplifier to A10 RF coupler
W6			A5 LO modulator/amplifier to A16 LO coupler
W7	N5260-20014	1	A10 RF coupler (via A11 attenuator) to A14 RF switch
W8	N5260-20012	1	A16 LO coupler to A19 LO power divider
W9	N5260-20007	1	A14 RF switch to front panel Port 2 RF OUT
W10	N5260-20008	1	A14 RF switch to front panel Port 1 RF OUT
W11	N5260-20005	1	A19 LO power divider to A15 port 2 isolator
W12	N5260-20006	1	A19 LO power divider to A20 port 1 isolator
W13	Z5623-60045	2	A13 detector to A9 test set interface control board
W14			A18 detector to A9 test set interface control board
W15	8120-5020	2	A9 test set interface control board to A6 RF modulator/amplifier
W16			A9 test set interface control board to A5 LO modulator/amplifier
W17	N5260-60016	4	Rear panel A IF to front panel A IF
W18			Rear panel R1 IF to front panel R1 IF
W19			Rear panel R2 IF to front panel R2 IF
W20			Rear panel B IF to front panel B IF

Figure 8-3 RF Cables

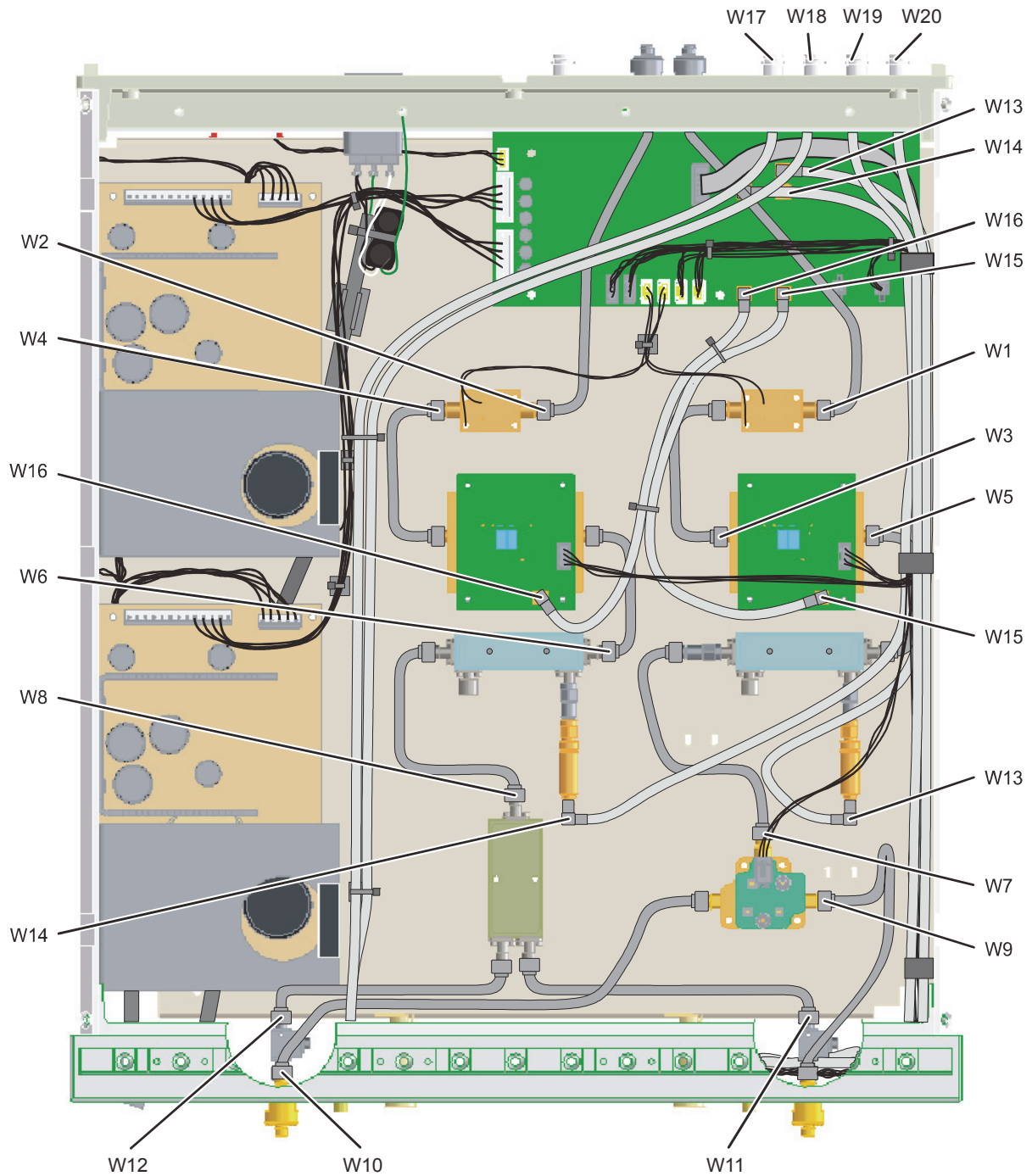

n5260_001_702

Wire Harness and Ribbon Cables

Reference Designator	Agilent Part Number	Qty	Description
①	Z5623-60048	1	A7 modulator/amplifier J2 to A9 test set interface control board P10
②	Z5623-60049	1	A4 modulator/amplifier J2 to A9 test set interface control board P11
③	Z5623-60050	2	A3 buffer amplifier to A9 test set interface control board P8
④			A8 buffer amplifier to A9 test set interface control board P9
⑤	Z5623-60052	1	Front panel LEDs to A9 test set interface control board J20
⑥	Z5623-60051	2	Front panel Port 1 BIAS to A9 test set interface control board P7
⑦			Front panel Port 2 BIAS to A9 test set interface control board P6
⑧	Z5623-60190	1	A14 RF switch to A9 test set interface control board P12 (SW1)
⑨	N5260-60015	1	AC line cable (includes A2 AC line module and ring wave filter)
⑩	N5260-60008	1	AC power supply cable
⑪	Z5623-60046	1	DC power cable from A21 power supply to A9 test set interface control board J3
⑫	87050-60021	1	DC power cable from A1 power supply to A9 test set interface control board J2
⑬	Fan cable. Connects to A9 test set interface control board P5. P/O fan assembly. See “Rear Panel” on page 8-14 for part number.		

Figure 8-4 Wire Harness and Ribbon Cables

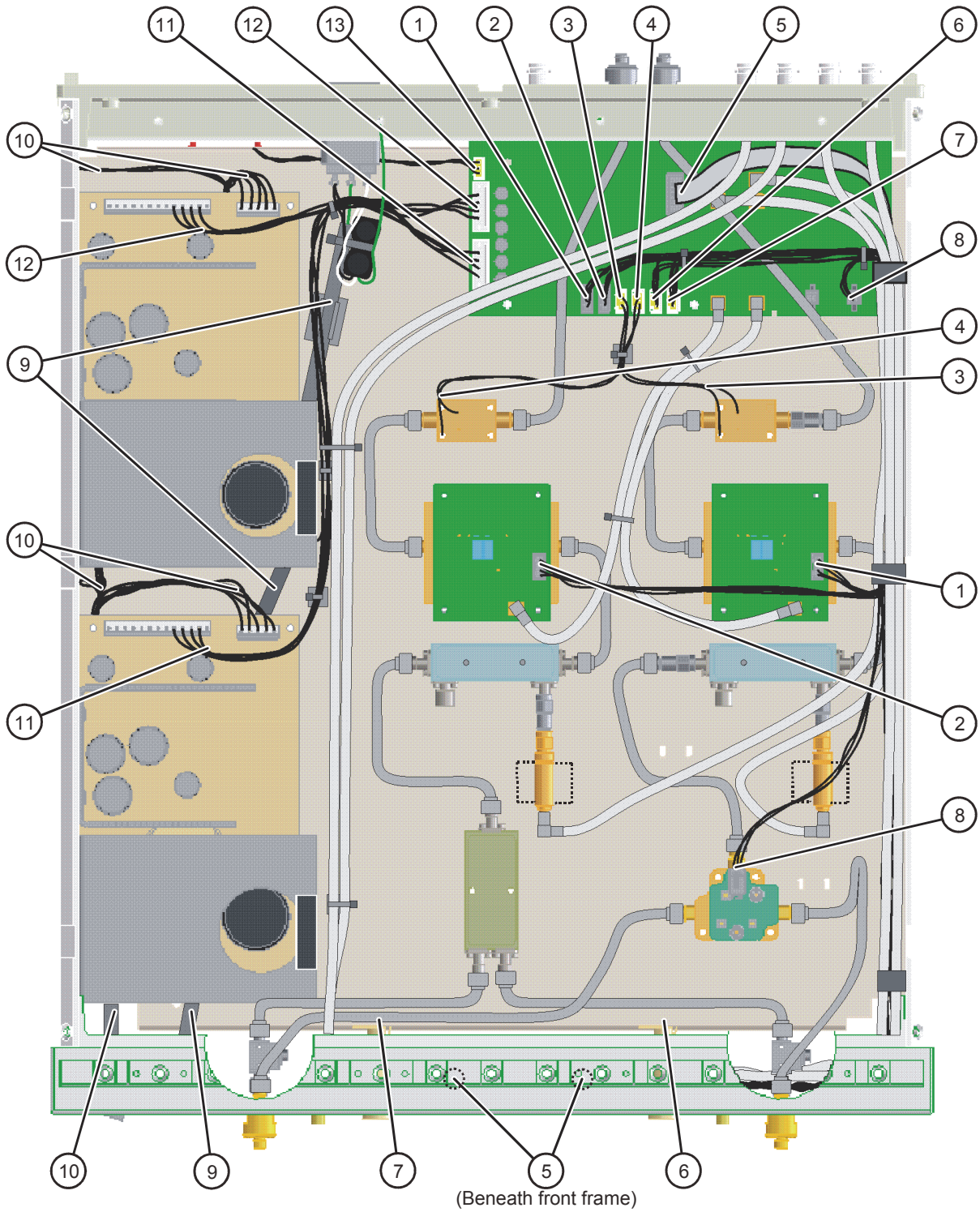

n5260_001_707

Internal Hardware and Miscellaneous Parts

Reference Designator	Agilent Part Number	Qty	Description
①	2110-0516	4	Fuse, 1A, 125V
②	2110-0520	2	Fuse, 5A, 125V
③	0515-0458	8	Machine screw, pan head, w/ captive lock washer, M3.5 x 8 mm
④	0515-0372	4	Machine screw, pan head, w/ captive lock washer, M3.0 x 8 mm
⑤	0515-0664	3	Machine screw, pan head, w/ captive lock washer, M3.0 x 12 mm
	1400-0025	3	Cable clamp
	3050-1192	3	Washer, flat, 3.8 mm ID
	0535-0031	3	Nut, hex, w/ captive lock washer, M3.0
⑥	0515-0375	8	Machine screw, pan head, w/ captive lock washer, M3.0 x 16 mm
⑦	0515-0372	16	Machine screw, pan head, w/ captive lock washer, M3.0 x 8 mm
⑧	0520-0128	4	Machine screw, pan head, 2-56 x 0.25 inch
	3050-0890	4	Washer, flat, 2.78 mm ID
⑨	0515-0372	4	Machine screw, pan head, w/ captive lock washer, M3.0 x 8 mm
⑩	0515-0666	2	Machine screw, pan head, w/ captive lock washer, M3.0 x 18 mm
⑪	0515-1382	6	Machine screw, 90-deg flat head, w/ captive lock washer, M3.5 x 6 mm
⑫	08712-80008	2	Foam pad, conductive
⑬	5002-4017	2	Shield, power supply
⑭	0515-0372	4	Machine screw, pan head, w/ captive lock washer, M3.0 x 8 mm
⑮	2360-0370	4	Machine screw, pan head, 6-32, 0.375 inch
	3050-1192	4	Washer, flat, 3.8 mm ID
⑯	0515-0372	8	Machine screw, pan head, w/ captive lock washer, M3.0 x 8 mm
⑰	0515-0458	2	Machine screw, pan head, w/ captive lock washer, M3.5 x 8 mm
	3050-1192	2	Washer, flat, 3.8 mm ID
	2190-0645	2	Washer, external lock, 3.65 mm ID
	0535-0024	2	Nut, hex, M3.5
⑱	1400-0755	7	Clip, component, (cable clamp), 0.25-inch diameter
⑲	1400-0493	1	Cable tie, 0.062 to 1.25-in diameter
⑳	1400-0249	27	Cable tie, 0.062 to 0.625-inch diameter
㉑	1400-1551	6	Mount, cable tie
㉒	E8356-20093	2	Foam tape

Figure 8-5 Internal Hardware and Miscellaneous Parts

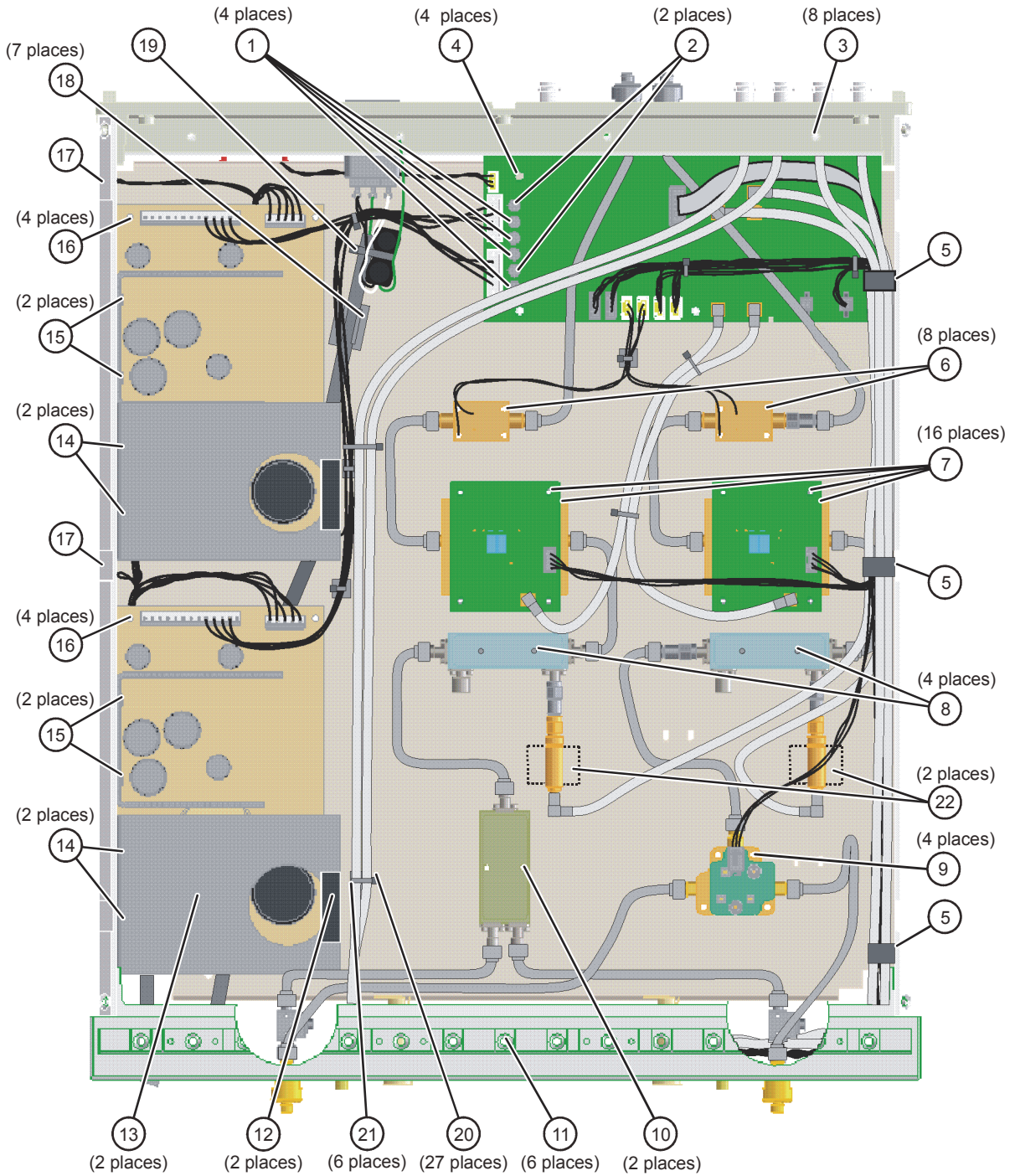

n5260_001_706

Rear Panel

Reference Designator	Agilent Part Number	Qty	Description
①	IF cable assembly. See “RF Cables” on page 8-8 for part numbers.		
	2190-0102	4	Washer, internal lock
	2950-0035	4	Nut, hex
②	5062-6618	2	3.5 mm bulkhead connector, female
	2190-0104	4	Washer, internal lock, 7/16 inch
	2950-0132	4	Nut, hex, 7/16 inch
③	1251-2942	2	Screw/lock washer kit for subminiature D connector
④	Test Set Interface I/O connector. Part of A9 test set interface control board. See “Internal Assemblies” on page 8-6 for additional information.		
⑤	0535-0031	5	Nut, hex, w/ captive lock washer, M3.0
⑥	N5260-60015	1	AC line module
	2110-1017	2	AC line fuse and spare line fuse; 3.0A, 250V, time-delay, 0.0480 ohm, socket
⑦	0515-1035	2	Machine screw, 90-deg flat head, M3.0 x 18 mm
⑧	87050-60027	1	Fan assembly (includes cable)
⑨	Z5623-00060	1	Rear panel
Not shown	6960-0149	1	Hole plug, for 0.5 inch diameter hole

Figure 8-6 Rear Panel

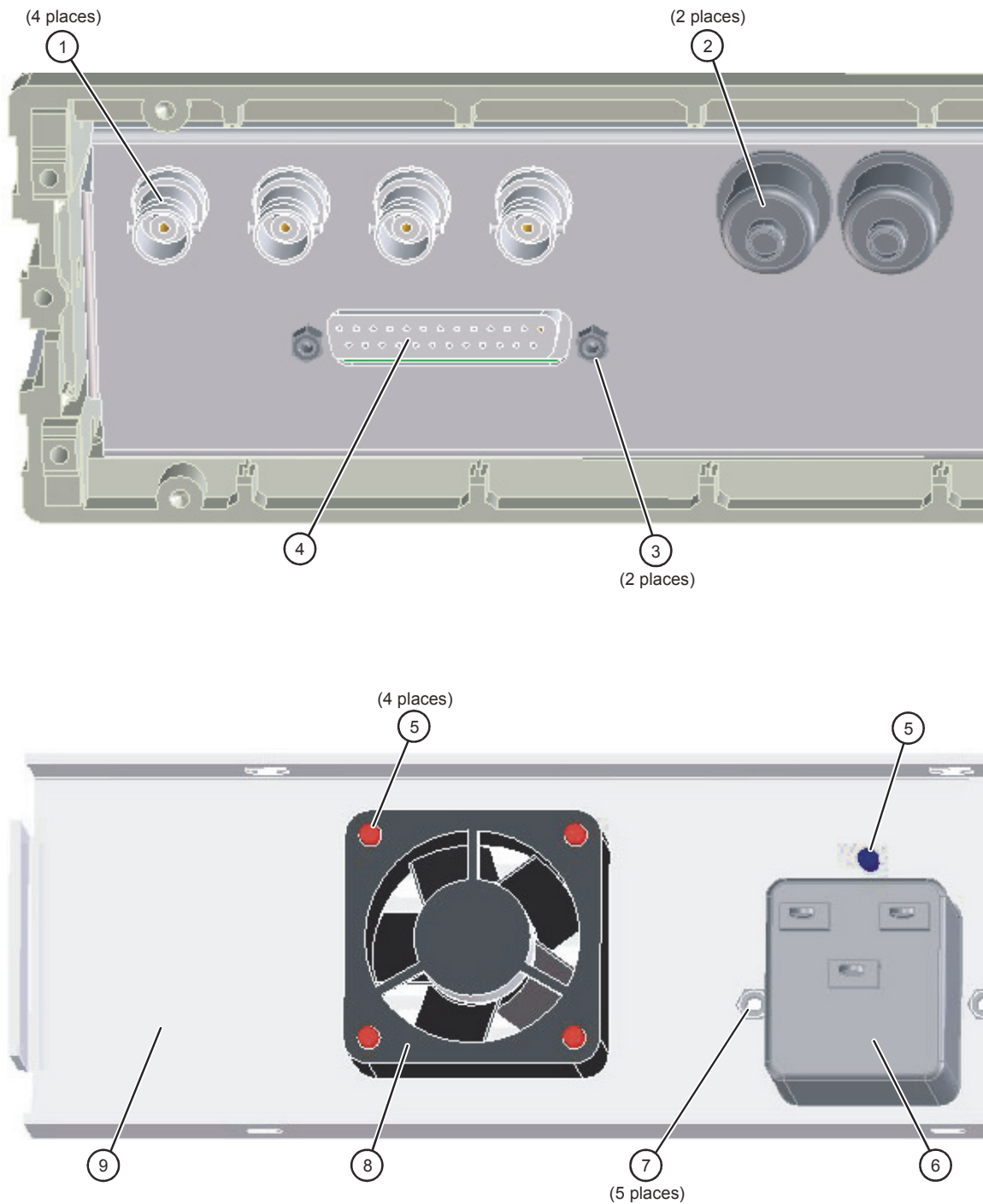

n5260_001_704

Chassis

Reference Designator	Agilent Part Number	Qty	Description
①	5021-5802	1	Rear frame
②	Z5623-00061	1	Deck
③	5021-5887	2	Side strut
④	0515-0458	12	Machine screw, pan head, w/ captive lock washer, M3.5 x 8 mm
⑤	0515-2086	8	Machine screw, 90-deg flat head, w/ captive lock washer, M4.0 x 7 mm
⑥	5022-1187	1	Front frame

Figure 8-7 Chassis

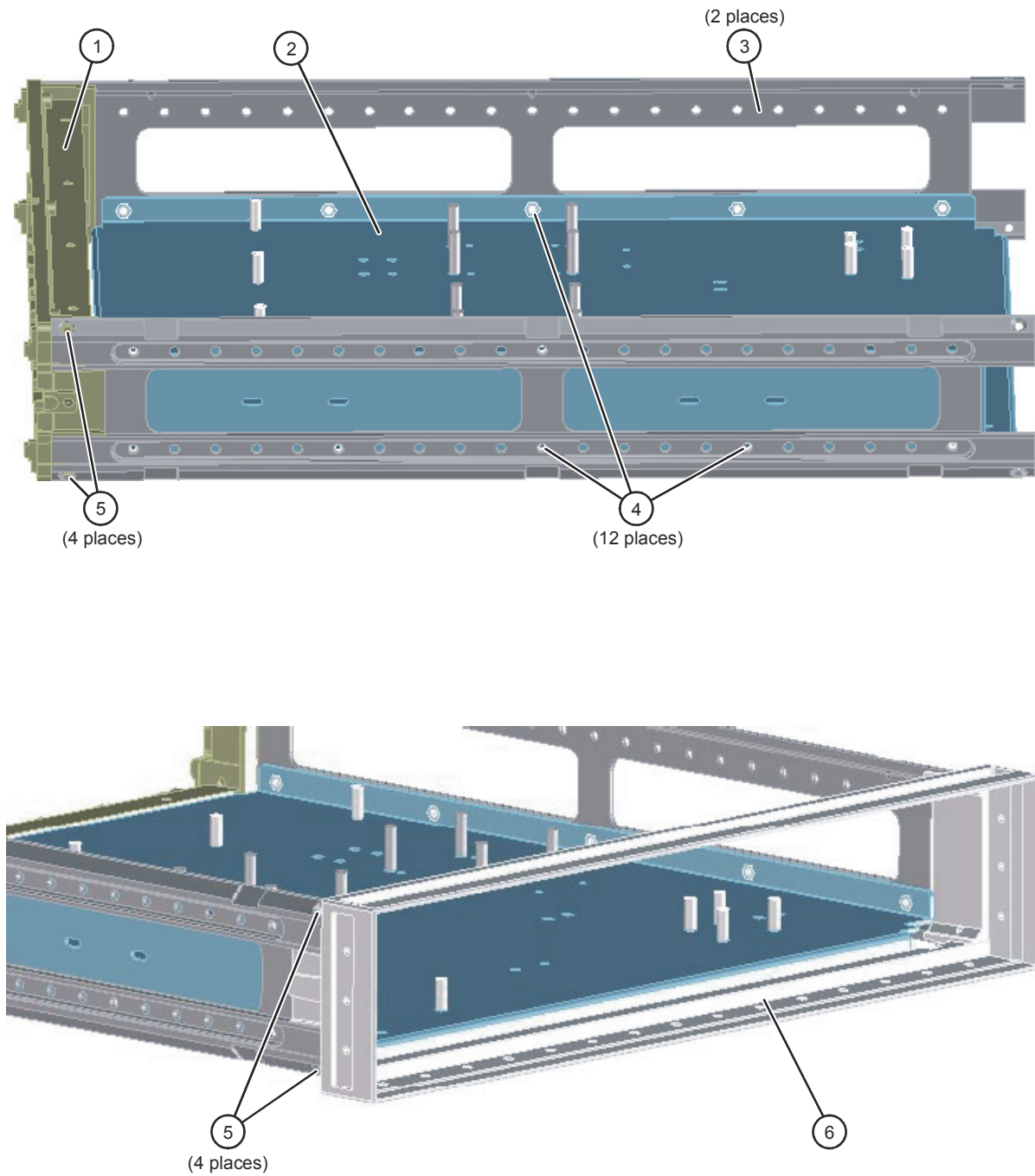

n5260_001_705

Miscellaneous

Agilent Part Number	Qty	Description
Documentation		
N5260-90001		Service Guide. (Not available in printed form. Part number is for reference only. Must be printed from the Agilent Web site. Refer to "Printing Copies of Documentation from the Web" on page iii.)
Accessory Cables and Adapters (Supplied)		
8120-1839	4	Cable, RG/223 coax, 24-inch, (rear BNC) cable on rear
8121-1221	4	Cable, 3.5 mm coax, male-to-male, 48-inch (front RF and LO cables)
85105-60030	2	Cable, external bias (front bias cables)
85105-60033	4	Cable, external IF (front IF cables)
08503-60051	1	Cable, interconnect (rear control cable)
1250-2604	4	Adapter, SMA, right angle
5061-9038	2	Cable, SMA, male-to-male, 24 inch
Protective Caps for Connectors (Supplied)		
1252-1935	1	Dust cover, subminiature D
1401-0245	10	Cap, protective
Rack Mount and Handle Kits (Supplied)		
5063-9226	1	Kit, front handle
5063-9232	1	Kit, rack mount flange (for instruments with front handles)
ESD Supplies (Not Supplied)		
9300-1367	1	Adjustable antistatic wrist strap
9300-0980	1	Antistatic wrist strap grounding cord (5 foot length)
9300-0797	1	Static control table mat and earth ground wire
9300-1126	1	ESD heel strap

Chapter 9: Test Set Adjustments and Tests

Information in This Chapter

Chapter Nine at-a-Glance

Section Title	Summary of Content	Start Page
Adjustment Procedures	Procedures for adjusting the N5260A test set.	Page 9-4
Test Procedure	Procedure for testing the N5260A test set.	Page 9-7

Conventions Used for Hardkeys, Softkeys, and Menu Items

The following conventions are used in this document:

Hardkey

This represents a “hardkey”, a key that is physically located on the instrument.

Softkey

This represents a “softkey”, a key whose label is determined by the instrument firmware.

Menu Item

This represents an item in a drop-down or pop-up menu.

Introductory Information

This chapter defines adjustment and test processes for the N5260A test set. The procedures do not assume specific instrument model numbers for test equipment. A variety of different model numbers may be used to perform these procedures. The process descriptions in this chapter do not provide complete detail. However, the RF test technician who is experienced with PNA network analyzers and general RF test equipment and techniques will find the information is sufficient.

The procedures in this chapter refer to a "PNA." This refers to any model of PNA or PNA-X that meets the frequency range requirements.

When Adjustments and Tests are Required

The Adjustment Procedure and the Test Procedure should be performed whenever an active component in the test set is replaced. The Test Procedure may be used to check RF and DC power levels as needed.

Required Test Equipment

- Multimeter - for measuring DC voltage; capable of measuring down to 1 mV.
- RF cables and adapters - as needed, to interconnect the PNA, power sensor, and test set.
- Test set interconnect cable (Test Set I/O to Test Set Interface)
- Network analyzer - PNA or PNA-X with maximum frequency range of 20 GHz or greater.
- Power sensor with compatible power meter (possible models include E4413A power meter with 8485A sensor) - frequency range of 6 GHz to 18.5 GHz; power range of -10 to +15 dBm; 3.5 mm connector type.

Controlling the N5260A Test Set with a PNA

NOTE The PNA used in the following procedures should be in its normal state. The PNA should not be configured to automatically control the test set. If a Millimeter Module Config menu is available, be sure to select the Standard PNA configuration.

1. Connect the test set interconnect cable between the PNA and the test set. See [Figure 3-4 on page 3-13](#).
2. Turn on the N5260A test set and the PNA.
3. Insure the PNA is in a continuous sweep mode. "Cont" should be displayed in the lower left-hand corner of the PNA display.
4. Open the "Interface Control" window on the PNA:
 - Older firmware: click **Channel > Interface Control...**
 - Newer firmware: click **Trace/Chan > Channel > Hardware Setup > Interface Control...**
5. In the Interface Control window, check **Enable Interface Control**.
6. In the Test Set I/O Control (addr. data) area, check **Enable Control**, and enter one of the following two digit commands. The PNA should be in continuous sweep mode.
 - 0.0 - neither port output active
 - 0.1 - RF output on Port 1
 - 0.2 - RF output on Port 2
7. Click **OK**.
8. Use the commands listed above to practice operating the test set. The front panel LED associated with each port will light when the output is active.

Setting the Sweep and Power Level Output on the PNA

1. If not recently done, zero and calibrate the power sensor you will use in the following procedure.
2. Preset the PNA.
3. Set the PNA for CW sweep (sweep type = CW time). This sets a continuous RF output on Port 1.
4. Set the PNA output frequency to 7.5 GHz.
5. Identify the cable that will be used to connect PNA Port 1 and the test set.
6. Connect the cable between PNA Port 1 and the power sensor.
7. Adjust the PNA power output level to read -6 ± 0.5 dBm on the power meter.

NOTE To avoid possible damage to the RF and LO inputs on the test set, do not modify the PNA power output level during the following adjustment and test procedures.

Adjustment Procedures

Bias Supply Voltage Adjustment

1. Turn on the test set.
2. Adjust the bias supply voltage to 12.5 ± 0.025 VDC
 - a. Measure the voltages on the N5260A front panel bias supply connectors.

Figure 9-1 Front Panel Bias Supply Connectors

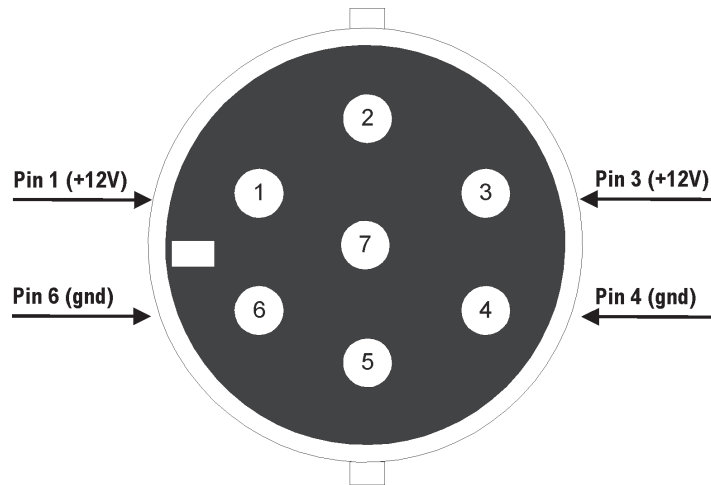

n5260_001_902

- b. The access for the adjustment is on the rear panel, labeled Bias Adjust - for its location, refer to [Figure 3-2 on page 3-6](#).

RF and LO Adjustments

1. Remove the top cover from the N5260A test set. See [Figure 9-2](#) for the location of test points and pots referenced in the following steps.

Figure 9-2 Test Point & Pot Locations on A9 Test Set Interface Control Board

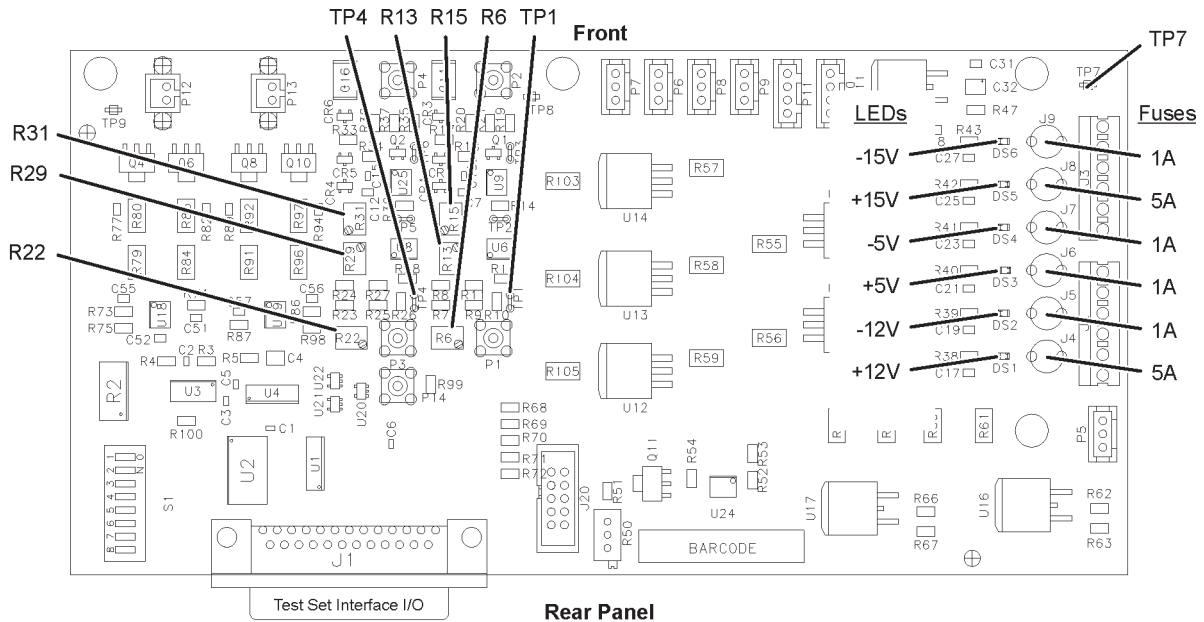

n5260_001_901

NOTE Make the following PNA power level setting BEFORE connecting the PNA RF output to the N5260A test set to avoid overpowering the test set inputs.

2. Leave the PNA frequency at 7.5 GHz, but set the PNA power level RF output as described in [“Setting the Sweep and Power Level Output on the PNA”](#) on page 9-3.
3. Zero and calibrate the power sensor to be used in the following procedure if it has not been done recently.
4. Center six pots on the N5260A A9 Test Set Interface Control Board: R6, R13, R15, R22, R29, and R31. These are 15-turn pots.
5. Turn on the N5260A test set.
6. Use the PNA to activate the RF output on Port 1 of the N5260A test set. See [“Controlling the N5260A Test Set with a PNA”](#) on page 9-3.
7. Connect the negative probe on the multimeter to TP7 as a ground reference.
8. Connect the PNA Port 1 to the LO input on the N5260A test set rear panel. Connect the power sensor to the Port 1 LO OUT connector on the test set front panel.
9. Connect the multimeter to TP1.
10. Adjust R13 as close as possible to zero volts (typically within 2 mV).

11. Adjust R6 to read 13.0 dBm \pm 0.1 dB on the power meter.
12. Adjust R15 as follows:
 - Confirm that R15 is in the “flat” range. R15 is in this range when you observe that the power meter reading changes less than 0.1 dB while the pot is turned one turn CW or CCW. If the pot is not in the “flat” range, adjust it two turns CCW and check again. Repeat as necessary to get the pot in the “flat” range.
 - The power meter reading is the nominal power level for the “flat” range.
 - Turn R15 CW one turn and monitor the power meter reading. Repeat until the power meter reading increases by more than 0.5 dB for one CW turn.
 - Turn R15 back until the power meter reads within 0.1 dB of the nominal power reading in the “flat” range. This positions R15 at the end of the “flat” range.
 - Turn R15 four turns CCW. This is the final position for the pot.
13. Connect the PNA Port 1 to the RF input on the N5260A test set rear panel.
14. Connect the power sensor to the Port 1 RF OUT connector on the test set front panel.
15. Use the PNA to activate the RF output on Port 1 of the N5260A test set. See [“Controlling the N5260A Test Set with a PNA” on page 9-3](#).
16. Connect the multimeter to TP4. Adjust R29 as close as possible to zero volts (typically within 2 mV).
17. Adjust R22 to read 13.0 dBm \pm 0.1 dB on the power meter.
18. Adjust R31 the same way that R15 was adjusted in [Step 12](#) on this page.
19. Replace the top cover on the N5260A test set.

Test Procedure

1. Turn on the N5260A test set.
2. Check the bias supply voltage on each connector. See [“Bias Supply Voltage Adjustment”](#) on page 9-4 for details.
3. Zero and calibrate the power sensor to be used in the following procedure if it has not been done recently.

NOTE Make the following PNA power level setting BEFORE connecting the PNA RF output to the N5260A test set to avoid overpowering the test set inputs.

4. Set the power level output on the PNA as described in [“Setting the Sweep and Power Level Output on the PNA”](#) on page 9-3.
5. Connect the PNA Port 1 to the RF input on the N5260A test set rear panel.
6. Connect the power sensor to the Port 1 RF OUT connector on the N5260A test set front panel.
7. Use the PNA to activate the RF output on Port 1 of the N5260A test set. See [“Controlling the N5260A Test Set with a PNA”](#) on page 9-3.
8. Manually step through the frequency range of 7.5 GHz to 18.5 GHz in approximately 0.25 GHz steps. At each frequency step, verify that the power meter reading is within the range specified in [Table 9-1, “Power Meter Test Limits,”](#) on page 9-8. If the power level is outside the specified range for any frequency step, the test has failed. See [“Frequency Step Macro”](#) on page 9-8 for instructions to create a macro that makes 0.25 GHz steps.
9. Connect the power sensor to the Port 2 RF OUT connector on the N5260A test set front panel.
10. Use the PNA to activate the RF output on Port 2 of the N5260A test set. See [“Controlling the N5260A Test Set with a PNA”](#) on page 9-3.
11. Manually step through the frequency range of 7.5 GHz to 18.5 GHz in approximately 0.25 GHz steps. At each frequency step, verify that the power meter reading is within the range specified in [Table 9-1, “Power Meter Test Limits,”](#) on page 9-8. If the power level is outside the specified range for any frequency step, the test has failed.
12. Connect the PNA Port 1 to the LO input on the N5260A test set rear panel.
13. Connect the power sensor to the Port 1 LO OUT connector on the N5260A test set front panel.
14. Manually step through the frequency range of 8.2 GHz to 18.5 GHz in approximately 0.25 GHz steps. At each frequency step, verify that the power meter reading is within the range specified in [Table 9-1, “Power Meter Test Limits,”](#) on page 9-8. If the power level is outside the specified range for any frequency step, the test has failed.
15. Connect the power sensor to the Port 2 LO OUT connector on the N5260A test set front panel.
16. Manually step through the frequency range of 8.2 GHz to 18.5 GHz in approximately 0.25 GHz steps. At each frequency step, verify that the power meter reading is within the range specified in [Table 9-1, “Power Meter Test Limits,”](#) on page 9-8. If the power level is outside the specified range for any

frequency step, the test has failed.

Table 9-1 Power Meter Test Limits

Frequency Range (GHz)	Minimum Power (dBm)	Maximum Power (dBm)
7.5 to 10	6.16	14.0
10 to 13	6.35	14.16
13 to 16	6.54	14.35
16 to 18.5	6.7	14.54

Troubleshooting

If one or more steps in the test procedure fail, perform the “[Adjustment Procedures](#)” on page 9-4.

Frequency Step Macro

The 0.25 GHz steps may be accomplished by manually entering individual frequency values. Alternately, the macro below may be used on the PNA to simplify the process of stepping through sequential frequencies.

Macro Content

```
Set PNA=CreateObject("AgilentPNA835x.Application")
Set chan=PNA.activechannel
chan.cwfrequency=chan.cwfrequency+250e6
```

To Install the Macro on the PNA

1. Copy the three lines of text above into a file and name the file "step_25.vbs". (Most pdf readers support cut and paste operations.)
2. Copy the file to the directory **C:\Program Files\Agilent\Network Analyzer\Documents** on the PNA.
3. On the PNA, click **Utility > Macro > Macro Setup** to open the Macro Setup window.
4. Use the down arrow key to highlight a blank line, then click **Edit**.
5. Enter a macro title of "step 0.25".
6. Browse to the file "step_25.vbs" created previously.
7. Click Open.
8. Click OK.
9. Click OK.

To Use the Macro

1. Set the desired starting CW frequency value on the PNA.
2. Press the **Macro/Local** key on the front panel.

3. Press the "step 0.25" softkey as desired to increase the frequency. The current frequency is displayed at the bottom of the trace window.

NOTE For more information on macros, search for "using macros" in the PNA Help index.

A

A1 power supply board
part number, 8-6
removal and replacement, 7-10

A10 coupler
part number, 8-6
removal and replacement, 7-18

A11 attenuator
part number, 8-6
removal and replacement, 7-20

A12 attenuator
part number, 8-6
removal and replacement, 7-20

A13 detector
part number, 8-6
removal and replacement, 7-20

A14 RF switch
part number, 8-6
removal and replacement, 7-22

A15 isolator
part number, 8-6
removal and replacement, 7-26

A16 coupler
part number, 8-6
removal and replacement, 7-18

A17 attenuator
part number, 8-6
removal and replacement, 7-20

A18 detector
part number, 8-6
removal and replacement, 7-20

A19 power divider
part number, 8-6
removal and replacement, 7-24

A2 AC line module
part number, 8-6
removal and replacement, 7-30

A20 isolator
part number, 8-6
removal and replacement, 7-26

A21 power supply board
part number, 8-6
removal and replacement, 7-10

A3 buffer amplifier
part number, 8-6
removal and replacement, 7-12

A4 modulator/amplifier
part number, 8-6
removal and replacement, 7-14

A5 bias board
part number, 8-6
removal and replacement, 7-14

A6 bias board
part number, 8-6
removal and replacement, 7-14

A7 modulator/amplifier
part number, 8-6
removal and replacement, 7-14

A8 buffer amplifier

part number, 8-6
removal and replacement, 7-12

A9 test set interface control board
part number, 8-6
removal and replacement, 7-16

AC line fuse
part number, 8-14
removal and replacement, 7-30

AC line module
removal and replacement, 7-30

AC symbol, 1-6

adjustment procedure, 9-4

Agilent
contacting, 2-7
support, 2-7

assemblies
internal
replaceable parts, 8-6
location of part numbers, 8-3
replaceable parts, 8-3, 8-6

attenuators
removal and replacement, 7-20

B

battery disposal, 1-7

before applying power, 1-3

bias boards
removal and replacement, 7-14

bias supply voltage adjustment, 9-4

block diagram
theory of operation, 6-6

buffer amplifiers
removal and replacement, 7-12

C

cables
interconnection, 2-3

cables, RF
replaceable parts, 8-8

cables, ribbon
replaceable parts, 8-10

cables, wire harness
replaceable parts, 8-10

cabling
front panel, 3-14
rear panel, 3-13
system, 3-16

calibration kit, 4-4

Canadian
Standards Association symbol, 1-6

care of connectors, 2-6, 3-11

care of waveguide, 2-5

caution, 1-3

CE symbol, 1-6

chassis parts
replaceable, 8-16

cleaning
connectors, 2-6

waveguide, 2-5

configuring PNA software, 3-17

connectors
care of, 2-6, 3-11
care quick reference, 2-6
cleaning, 2-6
front panel, 3-3
rear panel, 3-5
theory of operation, 6-5

contacting Agilent, 2-7

contents
checklist, 3-8
of shipment, 3-8

couplers
removal and replacement, 7-18

CSA symbol, 1-6

D

description
N5260A, 2-3

detectors
removal and replacement, 7-20

dimensions
N5260A, 6-4
system, 3-11
system components, 3-11

divider, power
removal and replacement, 7-24

E

earth ground, 1-3

electrostatic discharge, See ESD

environmental requirements
system, 3-10

equipment
required for troubleshooting, 5-3

ESD
protection, 1-5, 3-11, 7-3

European Community symbol, 1-6

F

fan
removal and replacement, 7-28

features
front panel, 3-3
rear panel, 3-5

frequency step macro, 9-8

front panel
connectors, 3-3
features, 3-3
N5260A, 2-3
replaceable parts, 8-4

front panel cabling, 3-14

front panel parts
removal and replacement, 7-6

fuses
AC line

part number, 8-14
removal and replacement, 7-30
power supplies
part number, 8-12
removal and replacement, 7-32

G

general safety considerations, 1-3
ground, safety earth, 1-3

H

hardware
location of part numbers, 8-3
hardware, internal
replaceable, 8-12

I

input and output connectors
theory of operation, 6-5
instrument documentation symbol, 1-6
instrument markings, 1-6
interconnection cables, 2-3
interface control board
removal and replacement, 7-16
internal assemblies
replaceable parts, 8-6
ISM1-A symbol, 1-6
isolators
removal and replacement, 7-26

K

kit, calibration, 4-4

L

line fuse, AC
part number, 8-14
removal and replacement, 7-30
line module, AC
removal and replacement, 7-30
lithium battery disposal, 1-7
LO section
theory of operation, 6-5
locating
assembly part numbers, 8-3
hardware part numbers, 8-3
miscellaneous part numbers, 8-3
long term storage of test results, 4-3

M

macro, frequency step, 9-8
maintenance
cleaning, 2-5
markings, 1-6
millimeter-wave test head module

cable connections, 3-15
miscellaneous parts
location of part numbers, 8-3
replaceable, 8-18
miscellaneous parts, internal
replaceable, 8-12
modulator/amplifiers
removal and replacement, 7-14

N

N5250A system
as shipped, 3-7
cable connections, 3-16
components
weights and dimensions, 3-11
environmental requirements, 3-10
front panel cabling, 3-14
power requirements, 3-9
rear panel cabling, 3-13
receiving, 3-7
shipment checklist, 3-8
shipment contents, 3-8
site preparation, 3-9
space requirements, 3-11
weight and dimensions, 3-11
N5260A
description, 2-3
dimensions, 6-4
front panel, 2-3, 3-3
operating temperature, 6-4
PNA + N5260A + OML banded
mm-wave, 6-3
power requirements, 6-4
rear panel, 3-5
repair, 7-4
specifications, 6-3
supplemental characteristics, 6-3
weight, 6-4
What's included?, 2-3

O

off symbol, 1-6
on symbol, 1-6
op check, 4-3
operating temperature
N5260A, 6-4
operation
theory of, 6-5
operation check, system, 4-3
option
service and support, 2-7
ordering information
replaceable parts, 8-2

P

part numbers

locating
for assemblies, 8-3
for hardware, 8-3
for miscellaneous parts, 8-3

parts

replaceable, 8-3
ordering information, 8-2

PNA software, configuring, 3-17

power divider

removal and replacement, 7-24

power requirements

N5260A, 6-4
system, 3-9

power supplies

fuses
part number, 8-12
removal and replacement, 7-32

power supply boards

removal and replacement, 7-10

procedure, test

, 9-7

procedures

adjustment, 9-4
repair, 7-4
troubleshooting, 5-5

protection

against ESD, 1-5, 3-11, 7-3

R

rear panel

cabling, 3-13
connectors, 3-5
features, 3-5
replaceable parts, 8-14

receiving

the system, 3-7

repair

procedures, 7-4
warnings about, 7-3

repair, system

, 5-11

replaceable parts

assemblies, 8-3
chassis, 8-16
front panel, 8-4
hardware, internal, 8-12
internal assemblies, 8-6
miscellaneous, 8-18
miscellaneous, internal, 8-12
ordering information, 8-2
rear panel, 8-14
RF cables, 8-8
ribbon cables, 8-10
wire harness cables, 8-10

results of test, long term storage

, 4-3

RF and LO adjustments

, 9-5

RF cables

replaceable parts, 8-8

RF section

theory of operation, 6-5

RF switch
removal and replacement, 7-22

ribbon cables
replaceable parts, 8-10

S

safety
considerations, 1-3
earth ground, 1-3
symbols, 1-3

service
contacting Agilent, 2-7
options, 2-7
procedures
 warnings about, 7-3
warnings, 1-4

shipment
checklist, 3-8
contents, 3-8
for service or repair, 2-7

site preparation
system, 3-9

software, PNA, configuring, 3-17

space requirements
system, 3-11

specifications
N5260A, 6-3
PNA + N5260A + OML banded
 mm-wave, 6-3

support
contacting Agilent, 2-7
options, 2-7
organization, 2-7

switch, RF
removal and replacement, 7-22

symbols, 1-6

system
as shipped, 3-7
cable connections, 3-16
components
 weight and dimensions, 3-11
environmental requirements, 3-10
front panel cabling, 3-14
operation check, 4-3
power requirements, 3-9
rear panel cabling, 3-13
receiving, 3-7
shipment checklist, 3-8
shipment contents, 3-8
site preparation, 3-9
space requirements, 3-11
weight and dimensions, 3-11
system installation and operation, 1-2
system repair, 5-11

T

test equipment

 required for troubleshooting, 5-3

test head module
cable connections, 3-15

test procedure, 9-7

test results, long term storage, 4-3

test set interface
theory of operation, 6-5

test set interface control board
removal and replacement, 7-16

theory of operation
block diagram, 6-6
input and output connectors, 6-5
LO section, 6-5
overall, 6-5
RF section, 6-5
test set interface board, 6-5

troubleshooting, 9-8
equipment required, 5-3
flowchart, 5-5
general, 5-3
procedures, 5-5

V

voltage adjustment of bias supply, 9-4

W

warning, 1-3
warnings for servicing, 1-4

waveguide
care of, 2-5
cleaning, 2-5

weight
N5260A, 6-4
system, 3-11
system components, 3-11

weight and dimensions
system, 3-11
system components, 3-11

wire harness cables
replaceable parts, 8-10

